



MUtation 1994





MUtation 1994

University of
Missouri - Columbia
School of Medicine

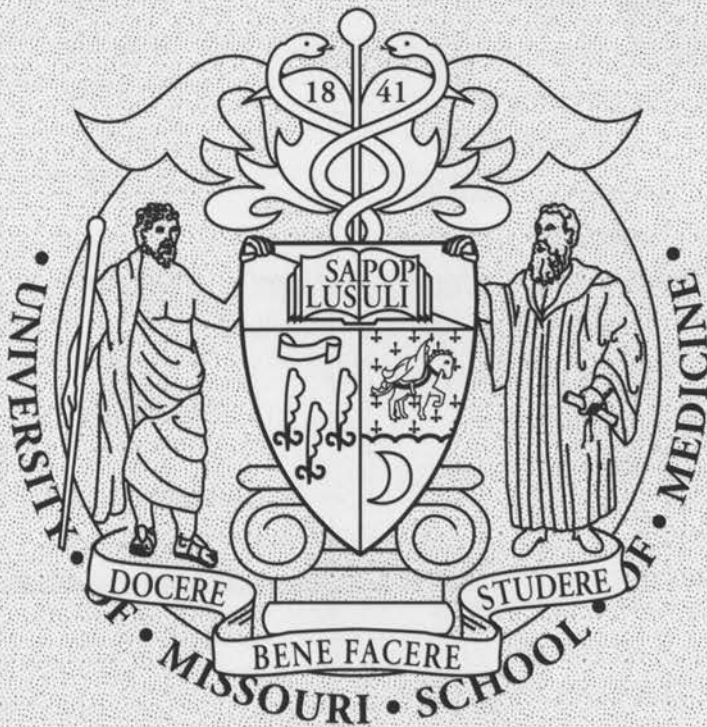

Volume XXXIV

Table of Contents

Benefactors	4
Office of the Dean	6
Student Life	8
Office of Medical Education	14
Faculty of the School of Medicine	16
Preclinical Departments	
PBL Block Leaders	18
Anatomy	20
Physiology	21
Biochemistry	22
Microbiology	22
Pharmacology	23
Pathology	24
Clinical Departments and Divisions	
Anesthesiology	28
Child Health	30
Emergency Medicine	32
Neurology	33
Family and Community Medicine	34
Department of Internal Medicine	36
Infectious Disease	39
Dermatology	40
Pulmonary	41
Cardiology	42
Immunology/ Rheumatology	43
Gastroenterology	44
Nephrology	44
Endocrinology	45
Hematology-Oncology	45
Obstetrics and Gynecology	46
Ophthalmology	48
Physical Medicine & Rehabilitation	49
Psychiatry	50
Radiology	52

Table of Contents

Department of Surgery	54
Vascular Surgery	54
General Surgery	55
Oncologic Surgery	59
Cardiothoracic Surgery	60
Neurosurgery	60
Urology	61
Plastic Surgery	61
Orthopedic Surgery	62
Otolaryngology	63
Faculty Candidates	64
Medical Student Organizations	65
M&AC	65
Mutation	68
AMA/ AMSA	70
AOA/ FPL	71
DSR/ SNMA	72
M-1s	74
A-Review	88
M-2s	92
M-3s	106
C-Review	120
M-4s	124
Senior Photos	138
Match Day - 1994	171
Graduation Activities	180
Bonfire	180
Dig Roast	181
Baseball Game	182
Graduation Banquet	184
Graduation Day	186
Honors and Awards	188
Advertisements	190
Editors Pages	204

PATRONS

William C. Allen, M.D.

Lester R. Bryant, M.D., Sc.D.

Thomas W. Burns, M.D.

Jay Dix, M.D.

Donald Doll, M.D.

Betsy Garrett, M.D.

Ted Groshong, M.D.

Ann Havey, M.D.

Terry Hoyt, M.D.

Joe Jacob, M.D.

Ramesh Khanna, M.D.

Robert N. McCallum, Ph.D.

Ezio A. Moscatelli, M.D.

William P. Patterson, M.D.

Hugh E. Stephenson, M.D.

Jan Swaney, M.D.

University of Missouri Medical School Foundation

Sara E. Walker, M.D.

Mary & Stephen Weinstein, M.D.

Steven J. Westgate, M.D.

Dana Ward, M.D.

SPONSORS



Ralph Braunschweig, M.D.

R. Phillip Dellinger, M.D.

Alberto & Michele

Diaz-Arias, M.D.

E.D. Everett, M.D.

Mehdi Farhangi, M.D.

Anne Fitzsimmons, M.D.

George Fuchs, M.D.

Robert W. Gaines, Jr., M.D.

Herbert S. Goldberg, Ph.D.

David Goldstein, M.D.

Darla B. Hess, M.D.

Richard A. Holmes, M.D.

Michael Hosokawa, Ed.D.

Elizabeth James, M.D.

David M. Klachko, M.D.

Alice Landrum, M.D.

Dennis Marienfeld, M.D.

Brent W. Miedema, M.D.

W. Kirt Nichols, M.D.

Mitch Rosenholtz, M.D.

Gilbert Ross, Jr., M.D.

Bill Salzer, M.D.

James Sowash, M.D.

Paul Sun, M.D.

Jerry Templer, M.D.

The Wakefield Family

Dana Weaver, M.D.

Dean's Message



Is a career as a physician still worthwhile? We hear that question in one form or another on a regular basis nowadays and I can certainly understand why. The efforts by third party payers to control health care costs have resulted in major changes in the perceptions of the public about our profession and how we deliver health care. Unfortunately, the politicians, aided by the shallow-minded media, have found it to their advantage to blame physicians for the mistakes made in Medicare and Medicaid, and even for the inability to address welfare reform. Meanwhile, the insurance companies have quietly lined their pockets with enormous profits and marveled at how cleverly they have avoided being identified as the really unnecessary component of the health care system.

Fortunately, there are other and more reliable indicators of the solid future of medicine. Unprecedented numbers of applicants to medical schools and to schools of nursing and allied health suggest that the youth of America are not fearful of a new health care delivery paradigm. Their confidence in the continuing satisfaction and rewards from serving their fellow citizens is supported by the ambitious and aggressive move of nurses and physicians assistants toward autonomous primary care. These groups will not be denied their opportunities, and I am assured that medicine will continue to be among the most desirable career choices into the next century.

My very best wishes to the Class of 1994.

Yours sincerely,

Lester R. Bryant, M.D., Sc.D.
Dean



Officers of Administration



Ted Groshong, M.D.
Associate Dean for
Medical Education



Michael C. Hosokawa, Ed.D.
Assistant Dean for
Curriculum



Robert N. McCallum, Ph.D.
Assistant Dean for
Student Programs



Hugh E. Stephenson, Jr, M.D.
Chief of Staff
University Hospital & Clinics
(and MUTation Hero!)

Timothy R. Rooney
Associate Dean for
Administration

Weldon D. Webb
Associate Dean for
External Affairs

Not Pictured:
Herbert Goldberg, Ph.D.
Associate Dean for Research
and Academic Affairs

Earl Dick, M.D.
Associate Dean for
Veterans Affairs

STUDENT LIFE



Why is this man grinning?



Welcome to the Prom.....Say CHEESE.

I'm serving 20 years for crimes unspecified.





Above:
If we could afford
color photos we would
know that Linnette is
flanked by two
redheads.

**Show us your teeth.
Great smiles.**



**After lunch at the cart,
Tim basks in the sun.**

**Help Steph...before she falls
off of the page.**



STUDENT LIFE



Jaron spies the secret MUtation camera at the picnic.



Eat right, sleep well and
lots of chemo.

A little Go-Lightly
makes Sarah & Steph
smile all day.



Dean Bryant wards off the paparazzi.





"Hey Keith,
I think they
are looking
at us."

"Quiet
Dennis.
You'll scare
them away."



"I found Phuong! I found Phuong!!"

Won't anyone carry Phil's books?



STUDENT LIFE



**Chanda, Tom, & Greg
Hold up Student Life.**



True Love!



**Boris runs the floor
with an iron fist.**

**Once again...
Free Pizza !**



**Lara & Jill can handle the
spicy food...like their men?**





**I wish I was at the VA.
I wish I was at the VA.**

PBL is a lot like being at a ball game.

Sally goes for the gold.



Above: a meeting of the minds.

Below: Allison poses with her beau.

The yuppies are coming!



**A quick
shot of
Sommer.**



Administration !!

and their most common quotes...



Conway Jones

"I know, I know...we all want more money."



Charmian Boyle

"Deadline for the Newsletter was yesterday!"



Sherry Boland

"Please, Please don't take my picture for the MUtation."



Erin Motley

"Sometimes...medical students just make me SCREAM!!"

Barbara Horrell
-Barb was spotted briefly at the Med School, between recruiting at the Ag school and Vet school.
Go Barb Go.





Denise Boessen

"Yes, you have to take chronic care."
"Yes you have to take another surgery."
"Let's check and see if you are going to graduate."



Roberta Settergren
"Well let's just call accounting and see how much is left in your class account."



Sandra McCurdy

"I don't care how much money you have...I can't just GIVE interviews."

Vicki Hamburg
"Dean Bryant is in a meeting right now. Do you want to see him in the morning?"



Carol Ritter
"Heh Heh Heh. I know what you're thinking."



Kathy Seay
"Hey, how would you like to give a tour? I'll get you a free lunch!"





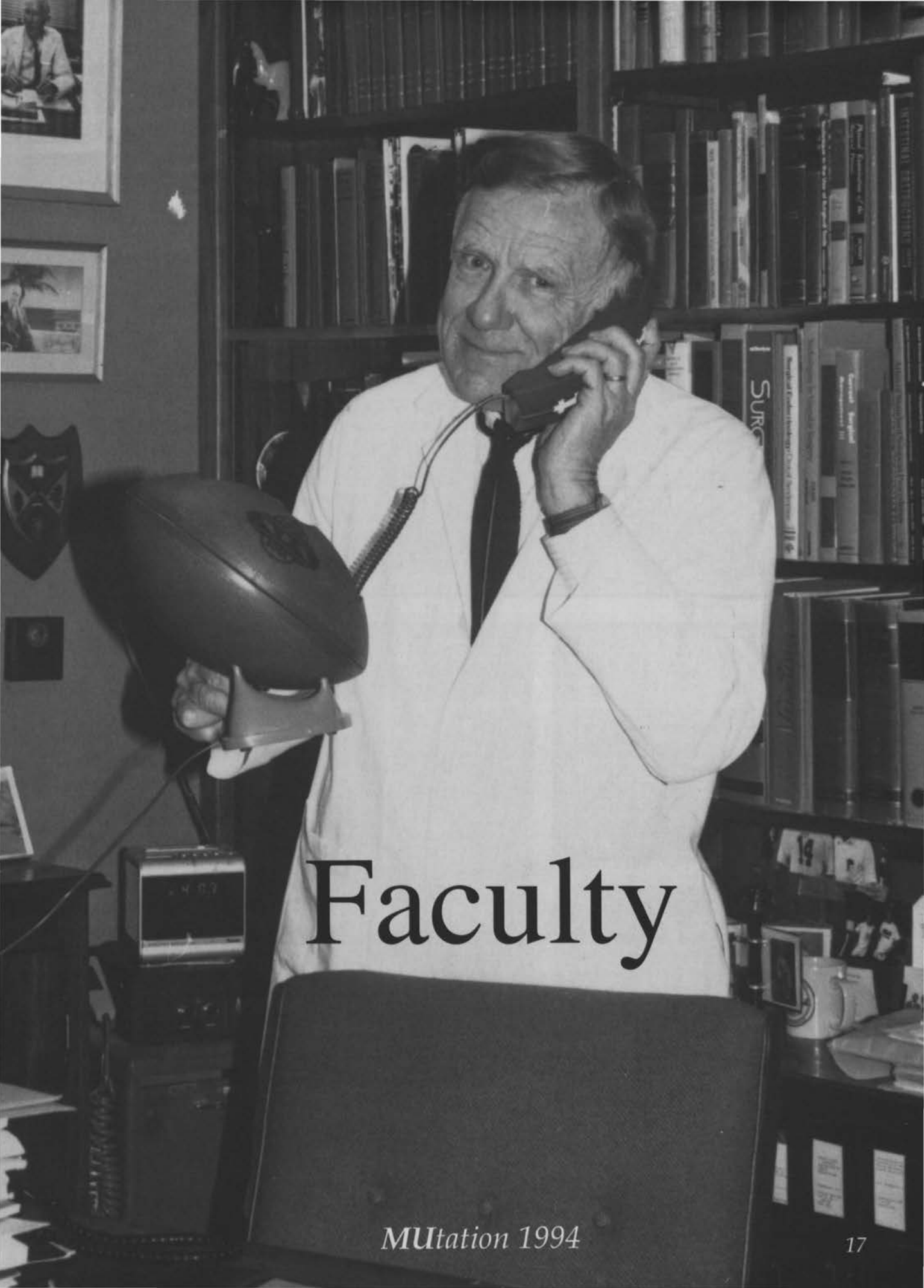

Faculty

Problem Based Learning



Michael Hosokawa, EdD
Assistant Dean for Curriculum

PBL--On your mark, get set,...

August 1, 1993: The curriculum design process had been like herding cats. Did we do everything we were supposed to do? Was everything in place? The new curriculum was ready--well sort of. The BSci and PBL were hooked up to the IPC which was connected to the SPX and ACE, the blockheads had tuned up the debriefers, the tutors were driving the SPs and the OME, the CDC and the CCDC were cleared for takeoff--or something like that. Time for a cimetidine.

The curriculum has exceeded all expectations. The students have responded positively to most experiences. There are a variety of roles for faculty and most have enjoyed new ways of teaching and the enthusiasm of the students. Designing and implementing a curriculum has not been easy or cheap. The faculty time and energy invested in education has been substantial. The investment in facilities, equipment and resources have been considerable.

The students like it. Most faculty like it. The LCME site visit team liked it. Several times I have heard a student say, "I love medical school; my friend at.....wishes he/she were here." Many revisions will be made in this curriculum, but we are off to a great start.

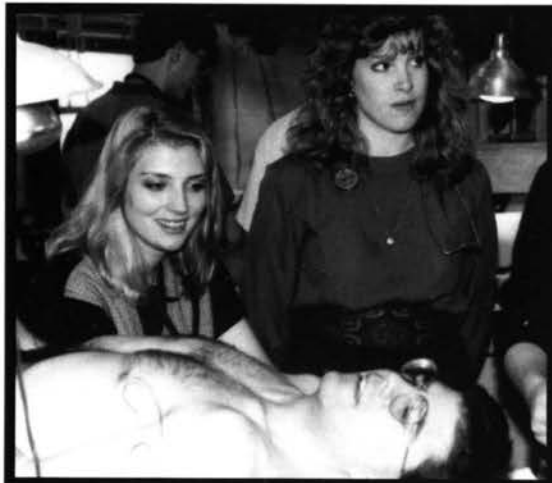

M-1s Taught by "BLOCKHEADS"

This represents some of the many basic science and clinical faculty who make up the framework of the PBL experience:



Sitting: Finley Gibbs, Anatomy; Kevin Rudeen, Anatomy; Larry Petterborg, Anatomy; Ezio Moscatelli, Biochemistry; Stephen Halenda, PhD
Standing: Ted Groshong, MD, clinical faculty; Kristofer Hagglund, PhD; Jim Campbell, PhD, Family & Community Medicine; Benedict Campbell, PhD, Biochemistry; Margaret Flynn, PhD, Family & Community Medicine; Robert McCallum, PhD, Office of Medical Education.



Sitting: Allan Jones, PhD, Physiology; Michael Hosakawa, EdD, Family & Community Medicine; Donald York, PhD, Neurosciences; Margaret Flynn, PhD, Family & Community Medicine.
Standing: Larry Petterborg, PhD, Anatomy; "stand-in" for Virginia Huxley, PhD, Physiology; Jan Swaney, MD, Clinical Faculty; Hammond Riggs, PhD, Microbiology; Robin Blake, MD, Family & Community Medicine; Jim Campbell, PhD, Family & Community Medicine.



Ann Havey, M.D.

Ann Havey, the director of the PBL/Basic Science Curriculum explains the alphabet soup of PBL:

"Blockheads" - the endearing term given to the director of each of four blocks during the academic year.

Tutor - a faculty member who guides discussion and evaluates performance and participation of students during the small group problem-based learning sessions.

IPC - Introduction to Patient Care: a major component of the new curriculum, which covers physical exam and interviewing skills, health care system issues, biomedical ethics, clinical epidemiology, and psychosocial issues.

SPX - Standardized patient Program: paid community volunteers are taught to portray patients with specific diseases, allowing students to practice their history, physical exam and interviewing skills. Sometimes used to evaluate student performance.

ACE - Ambulatory Care Experience: a program begun early in the first year, introducing students to primary care outpatient experiences in community physicians' offices and hospital clinics.

ANATOMY



Willis Paull, PhD
Director of Anatomy



William Godge, PhD
Professor

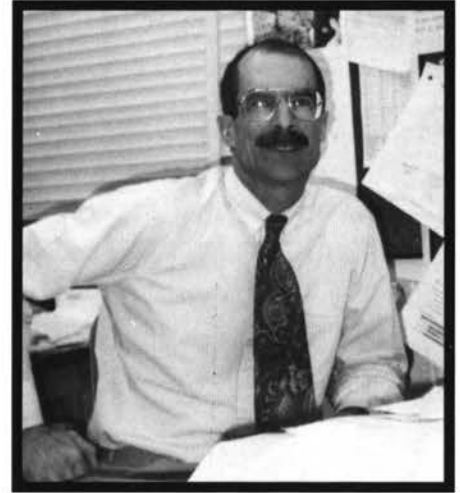

Finley Gibbs, PhD
Associate Professor



Gary Dunkerly, PhD
Associate Professor



Kevin Rudeen, PhD
Professor

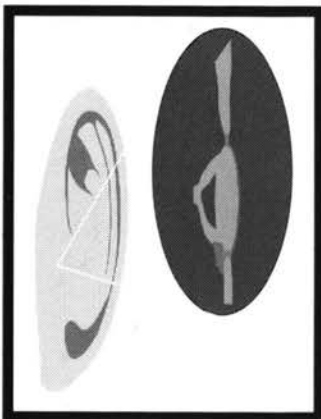

Thomas Scanlon, PhD
Assistant Professor



Sandra Peterson, PhD
Assistant Professor

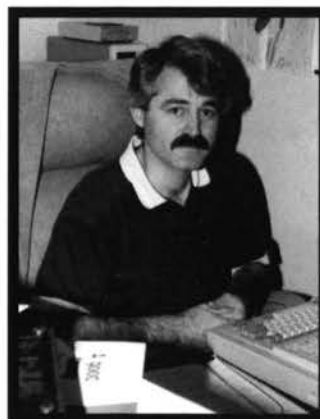

Robert Zoeller, PhD
Assistant Professor



William Krause, PhD
Professor

PHYSIOLOGY



Allen W. Jones, PhD
Professor & Chairman



Douglas Griggs, PhD
Professor Emeritus



Ronald Freeman, PhD
Professor



Mark Milanick, PhD
Associate Professor



Michael J. Rovetto, PhD
Professor



Donald York, PhD
Professor



J. Alan Johnson, PhD
Professor



Lene Holland, PhD
Assistant Professor



Michael Sturek, PhD
Associate Professor



Thomas W. Hurley, PhD
Associate Professor



Virginia Huxley, PhD
Associate Professor

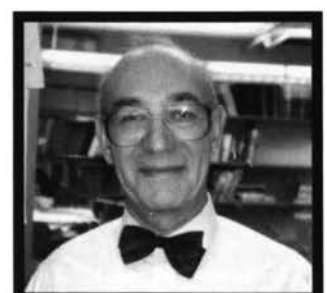
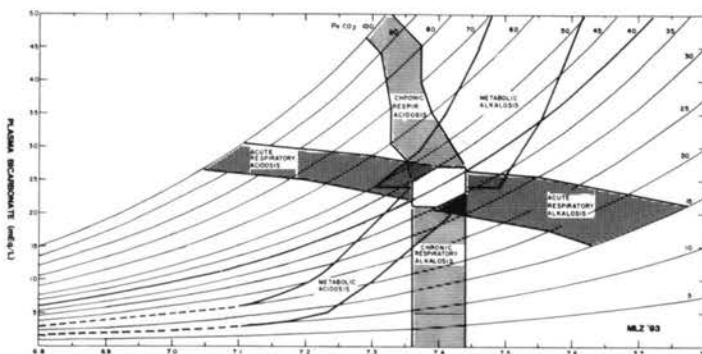

Marvin L. Zatzman, PhD
Professor Emeritus -

BIOCHEMISTRY

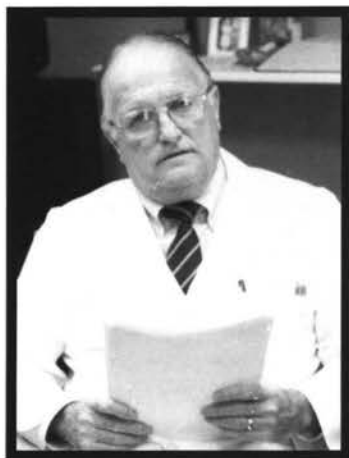

Benedict J. Campbell, PhD
Professor



Ezio A. Moscatelli, PhD
Professor



Francis J. Schmidt, PhD
Professor

Not Pictured:
William R. Folk,
PhD
Professor and Chair
Richard E. Hillman,
MD, PhD
Professor, Child
Health

MICROBIOLOGY



Seated: Charlotte Parker, PhD, Professor & Interim Chair; Mary Boesman-Finkelstein, PhD, Research Assoc. Professor; Richard Finkelstein, PhD, Curator's Professor; Karen Bennett, PhD, Assoc. Professor.
Standing: John F. Cannon, PhD, Assistant Professor; David R. Lee, PhD, Asst. Professor; Ramareddy V. Guntaka, PhD, Professor; Helen Braley-Mullen, PhD, Professor; Mark Misfeldt, PhD, Professor; Olen Brown, PhD, Professor; Hammond Riggs, Assoc. Professor; Kim Wise, PhD, Professor; David J. Pintel, PhD, Assoc. Professor; Mark A. McIntosh, PhD, Professor; Gregory MacDonald, PhD, Asst. Professor.

PHARMACOLOGY



Albert Y. Sun
Professor



Hyun Dju Kim, PhD
Professor & Chair

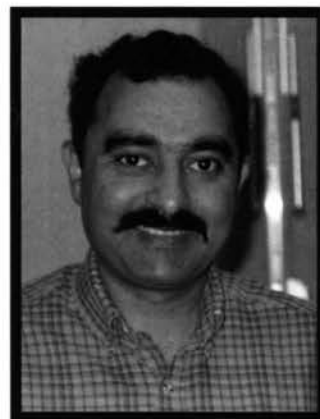

Shivendra D. Shukla
Professor



John Turner
Associate Professor



Stephen Halenda
Associate Professor

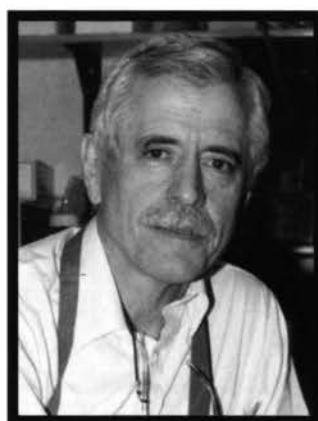

Keith Byington
Associate Professor

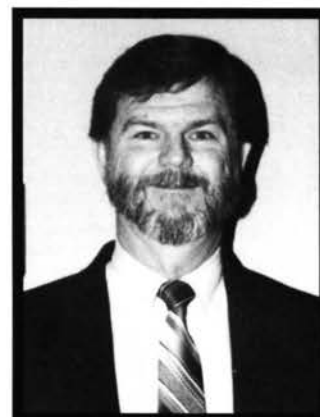

H. Richard Adams
Dean, School of Vet Med



Marilyn James-Kracke
Assistant Professor



Hattie Gresham
Assistant Professor



Jesse Bowen
Assistant Professor



Judith Cole
Research Assistant
Professor

PATHOLOGY



MARIA'S PERSPECTIVE

When I started medical school in 1986, I was like that old movie "I Led Three Lives." I had already led two of them and had started on my third. I had taught high school for the first one, fixed pinball machines, jukeboxes and video games for the second one, and was working on my third. There was a period of time during Life #2 that I was one of the famous 37 million uninsured. Let me get out my calculator and show you why.

Ok...Life #1...Maria Evans, aka Miss Evans, high school biology teacher. My top salary (1982) = \$10,800. My health insurance costs = \$10.80/month x 12 months = \$129.60 / year, or 1.2% of my gross income.

Now fast forward to life #3...Maria Evans, aka Dr. Evans, pathology resident. According to my W4 for 1993, I made \$30,796. My health insurance costs (I'm upscale now...I have dental coverage, too) = \$38.94/month x 12 months = \$467.28 / year, or 1.5% of my gross income.

Finally, two steps forward and one step back. Life #2...Maria Evans, pinball fixer in a family owned business in rural Missouri. My top salary (1985) = \$8788. Because it was a family owned business, I had no "bennies" at all...no retirement, no profit-sharing, and NO health insurance. I went out and priced health insurance once, in 1983. The best offer I found would have cost this healthy, then 23 year old \$275.29 every three months for a policy that was just

plain shabby. Limited ER coverage, limited hospital stay, and only \$500,000 total coverage limits. Time to get out the calculator again...\$275.29 x 4 quarterly payments = \$1101.06 / year, or 12.5 % of my gross income! No bargain, eh?

I know...you skeptics are saying, "Yeah, Maria...but what about your POST-tax income? You didn't pay as much in taxes then." Well, I got out my old tax returns (my tax lady would LOVE me!) Without boring you with the math, I re-figured this for these same 3 years and they came out to be 1.5% (Maria the teacher), 1.8% (Maria the resident), and 13.4% (Maria the pinball jock). Looks worse now, doesn't it?

Then I started thinking about all those folks I see on C-SPAN and CNBC talking about the famous 37 million uninsured. The Rush wannabes like to claim they're lazy freeloaders with poor financial planning skills. The bleeding-heart do-gooders tell me those folks are victims. I don't think I was ANY of those things back when I was one of the 37 million uninsured. I was just a bored young adult looking for something better. I wasn't a "victim"...I chose that job...but it took a while for me to figure out just what I wanted to do to better myself. I don't think I would have been accused of poor planning skills because of my inability to wall off eight and one-half times the amount of money I presently set aside for health care. To top it off, I'm single. I had it easy. I wasn't trying to raise a family and pay for this stuff, too. I don't find it surprising that I decided to forego health insurance.

Like many of you, I find myself grumbling about "health care reform". But I stop grumbling when I'm reminded of Maria's life #2. I don't think people who would have to set aside 12.5% of their gross income are too sympathetic when we holler that our potential incomes might be cut from \$150,000 to \$70,000. I'm willing to bet that if Maria #2 had been a patient at the University Hospital and overheard Maria #3 in the cafeteria talking to her colleagues, on some days she might have thought Maria #3 was a whining, conceited jerk. I learned early on in my residency never to complain about money in front of my relatives...because Maria, the underpaid resident, is the highest paid member of her entire family...and my student loans mean nothing when you look at the fact that my relatives are buying houses and cars with much less and struggling to make the payments AND rearing their families.

The only way that physicians, as a group, will garner support for their views on health care reform is if we truly put those 37 million first--then, and only then, will the public be sympathetic to our special needs and circumstances. There are a lot of ways to do this. One way is to be active in organized medicine--especially at the local level. Another is to donate your time and service to charitable efforts in providing medical care to underserved populations. The best, however, is to make sure that the people that you come in contact with KNOW THAT YOU CARE. Make a promise NOW that you will be active in building a new health care delivery system for this country, not just stand idly by while the system builds itself. Maria #3 is already proud of you. Now make Maria #2 proud.

PATHOLOGY

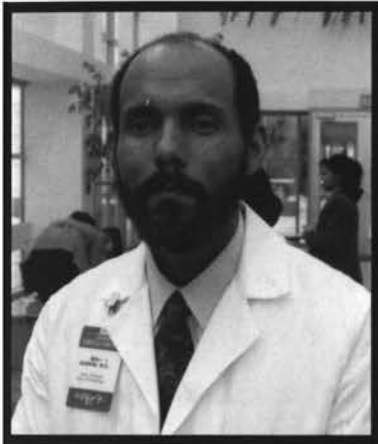

Ellis Ingram, MD
Associate Professor

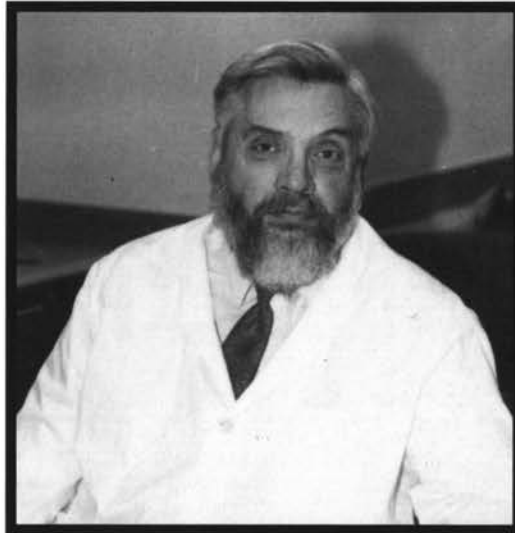

John Townsend, MD
Professor and Chair

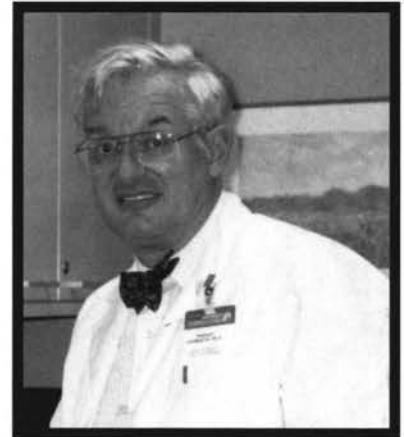

Helmut Haibach, MD
Associate Professor
& hormone guru



Mitch Rosenholtz, MD Professor
*Calling the Psychic Friends hotline to get
the inside scoop on this year's match results*



Eddie Adelstein, MD, DVM
Associate Professor
Is kicked out of the O.R. once again...



Ann Havey, MD
Associate Professor



Imelda Bulatao, MD
Assistant Professor



John Bickel, MD
Associate Professor
Demonstrates his priorities in life.

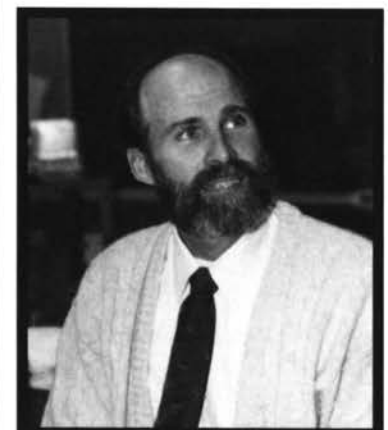

Jay Dix, MD
Associate Professor

PATHOLOGY



Tim Loy, MD
Associate Professor



***Paul Sun, MD, Assistant Professor, knows how to prevent folate deficiency

RIGHT:
Alan Lugar, MD, Associate Professor in his usual quiet, pensive mood.



Linda Spollen, MD
Associate Professor

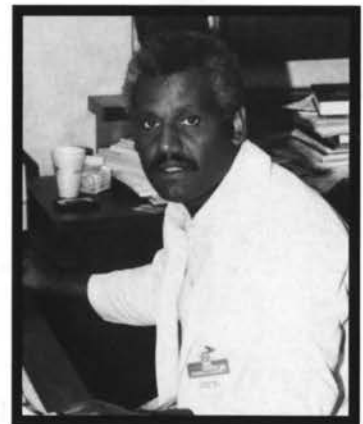

Yohannes Yesus, MD
Associate Professor



Dan Smith, MD
Assistant Professor



Charles Caldwell, MD
Associate Professor



Alberto Diaz-Arias, MD
Assistant Professor

The Department of Pathology is the home of many proud patrons and sponsors of the 1994 MUtation as well as the home of many fine teachers. We have recognized our sponsors and patrons in this department by surrounding their names with stars.

PATHOLOGY



David Springer, MD



Bill Birkby, MD



Dolph Haege, MD



Marcus Nashelsky, MD



LEFT: *Ahh, the life of a pathology resident...Eric Sheffer, MD making a STAT call to Domino's for lunch.*

NOT PICTURED:
Bob Calaluce, MD
Phu Tran, MD

POST SOPHOMORE FELLOWS:



Erica Kohanowski



John Spalding

Spend a year working and learning in Pathology



LEFT: Maria Evans, MD, in a great picture from a few years ago. Are those uteri on the left?

"Pathology is like.....a bridge between basic science and clinical medicine." --Sandy Sharp, MD



Jackie McKenzie, MD



Dan Gwartney, MD



Bart Shaw, MD



Monica Zill, MD

ANESTHESIOLOGY



LEFT:
Noel
Lawson,
MD,
Professor



LEFT:
Susan
Krechel,
MD,
Associate
Professor



GWN Eggers, MD,
Professor & Chair uses
his calculator to show....



Nila Gupta, MD
Assistant Clinical
Professor

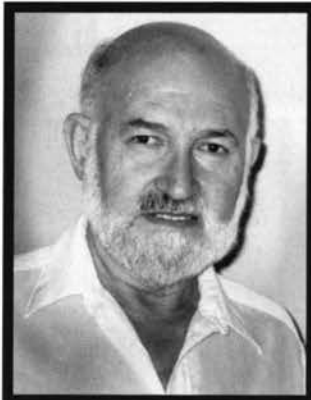

Ralph Braunschweig, MD
Assistant Clinical Professor



Louise Lowry, MD
Associate Clinical Professor



Robert Fisher, DO
Assistant Clinical Professor

NOT PICTURED:
Barbara Keller, MD
(and former MUltant leader)
Shari Leubrecht, MD
Walter Stewart, MD



Alice Landrum, MD
Assistant Clinical Professor



Mike Brown, MD
Instructor



Jon Taylor, MD, Instructor



Brian McKenna, MD, Instructor



E. Scott McCord, MD
Associate Professor

ANESTHESIOLOGY



...Ed Ortiz, MD, Resident,
how one can survive on a
resident's salary.

NOT PICTURED

Andrew Abele
William Anast
Chance Jeunger
David Lenser
Tim Metz
Sundar Rajendran
Thomas Schnurr
Terry Shedden
Tria Wilhite
Rick Wolkowitz



ABOVE: Residents Joe Valley, Mike
Thompson, Jay Shelton, and
Lynn Whitmer enjoy a break away
from the O.R.



Mark Zeiler, Tom Grisson, Joe Taylor, Alan Mead
demonstrate the spectrum of Anesthesia casual wear.

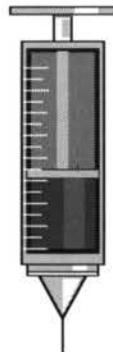

RIGHT: Kumiko Shimoda
BELOW RIGHT: Erik Schneckloth
BELOW: Sydney Gailey



Ron Rumpf, MD



Jon Faeth, MD



Duane Maynard, Jay Faurot, Ed Ortiz and Jimmy Dunn
hanging out in the anesthesia lounge.

CHILD HEALTH



Elizabeth James, MD
Professor



Zuhdi Lababidi, MD
Professor

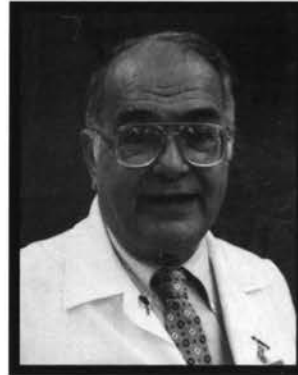

Giulio Barbero, MD
Professor Emeritus

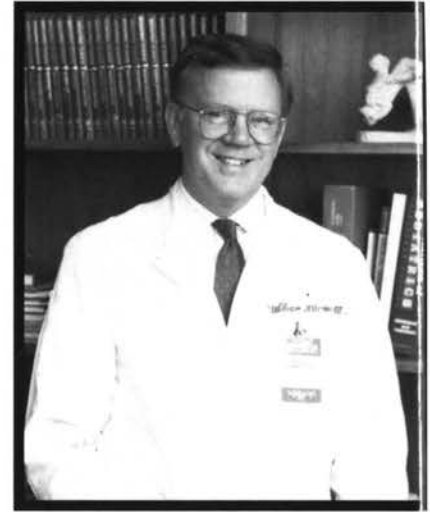

William Altemeier, MD
Professor & Chair



Nasrollah Hakami, MD
Professor



Peter Konig, MD, Professor, &
Chris Oermann, MD, fellow



Sara Sotiropoulos, MD
Assistant Clinical Professor



Frank Clark, MD, JD,
Assistant Clinical Professor



Laura Hillman, MD
Professor



Tom Selva, MD, & Tim O'Connor,
both Assistant Clinical Profs.

RIGHT:
Willard
Avery,
MD,
Douglas
Beal, MD
at Green
Meadows



**NOT
PICTURED:**
Guy Carter,
David
Fleischer,
Harry Stoeckle



LEFT:
George
Sotiropoulos,
MD
&
Bernhard
Allgaier,
MD, R-2

RIGHT:
Ted
Groshong,
MD, &
David
Goldstein,
MD



CHILD HEALTH

NOT PICTURED:

Manzoorul Farooqi
Sally Fortner
Barbara Gruner
Sabine Iben
Etihad Al-Falahi
Ingrid Kuhnle
Imran Sajan
Shanna Hall

RIGHT:
Michael
Cooperstock,
Associate
Professor
from a few
years back.



Judith Miles, MD
Professor



John Pardalos, MD
Chief Resident



Mr. Dr. Hillman, MD, PhD, always entertains on walking rounds



Indriati Tedja, MD, R-1



Laurie Fowler, MD, R-1

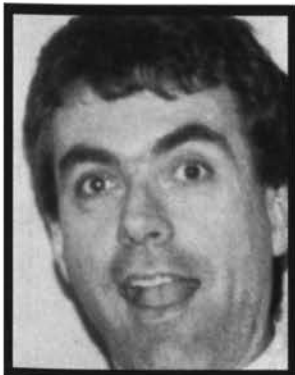

Dave Olson, MD, R-1



Ming Chen, MD, R-3

**Integrated
Residency
Program
in
Pediatrics:**
Joann Schumer,
M-4
Paula Stuebben,
M-4
Chris Hicks,
M-4



Zahid Amin, MD, R-2, Joanne Schumer, M-4,
& Holly Bondurant, MD, R-1.



LEFT:
Shiv
Someshwar,
Ramon
Lacanilao,
& Marcus
Schamberger

RIGHT:
Rebecca
Wotherspoon,
Nadereh
Varamini,
& Lan
Tran-Phu



FAMILY MEDICINE



William C. Allen, MD
Professor Emeritus



Margaret Flynn, PhD
Professor Emeritus



Jack Colwill, MD
Professor & Chair



Gerald Perkoff, MD
Curators Professor Emeritus



Robert Blake, MD
Professor



Michael Hosakawa, EdD
Professor



James Campbell, PhD
Associate Professor



Bernard Ewigman, MD
Associate Professor



Michael LeFevere, MD
Associate Professor



Georgia Nolph, MD
Associate Professor



David Vernon, MD
Associate Professor



Harold Williamson, MD
Associate Professor



Steven Zweig, MD
Associate Professor



Allen Daugrid, MD
Associate Clinical Prof.



Daniel Vinson, MD
Assistant Professor
32



Anne Fitzsimmons, MD
Assistant Clinical Prof.

NOT PICTURED:
Donald Spencer, MD
David Mehr, MD
Joseph Beckman, MD
Debra Howenstein, MD
Lisa Pierce, MD
Lee Chambliss, MD, Fellow



Elizabeth Garrett, MD
Associate Clinical Prof.

FAMILY MEDICINE



Laurel Walter, R-2



Ray Carter, R-2



Jerry Mank, R-1



Jared Block, R-1

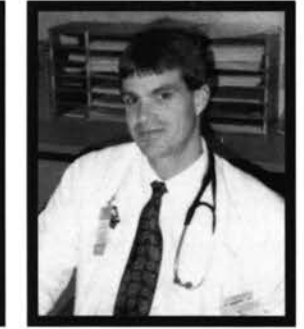

Gene Draves, R-1



Pamela Weisman, R-1



Nancy Tramil, MD & Jim Stevermer, R-2s
Residents work in teams and form strong bonds.



Pat Herrick, R-2



Bridget Earley, R-1

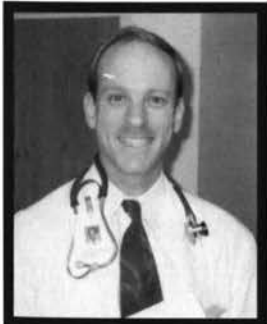

Mark Ellis, R-1



Ruanne Stamps, R-3



Paul Bloomquist, R-2



Brian Mahaffey, R-1

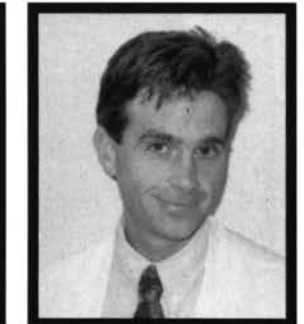

Pat Williams, R-2



Mary Beth McCoy, R-1



Cully Bryant, R-1



Deborah Weems, R-1



Justin Jones, Chief Res.

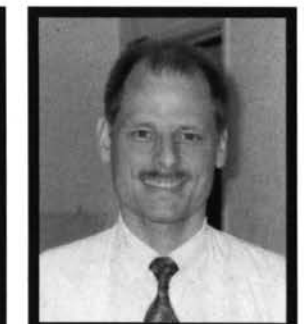

Doug Mills, R-1



LEFT:
Mary
Michener,
R-3 & Paul
Fast, R-3

RIGHT:
Wes Scoles,
Extern,
&
John Delzell,
R-1



EMERGENCY MEDICINE



William Musick, MD



Michelle Cates, MD

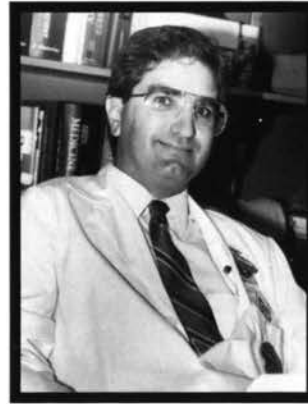

William Womack, DO



John Jermyn, MD



LEFT:
Quietly waiting for all hell to break loose



RIGHT:
The Staff for Life 'copter that saves lives

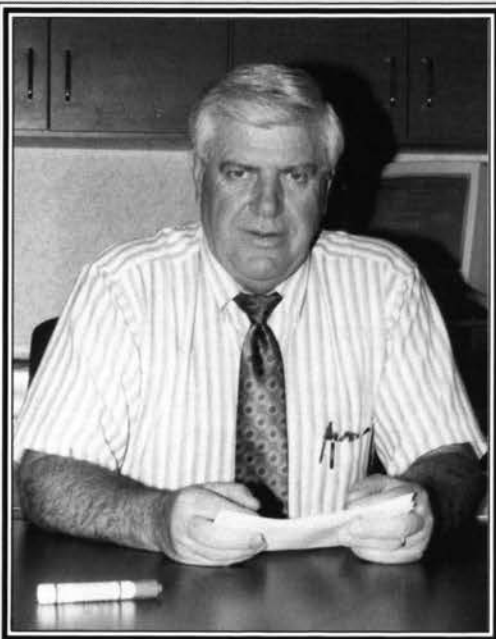

IN MEMORIUM

DEAN ALAN NIERLING, MD

Dr. Nierling died November 9, 1993, at age 58. Dr. Nierling received his medical degree at the University of Iowa in 1960. From 1961 to 1963 he served in the U.S. Air Force as chief of the outpatient department at Warren Air Force Base, Cheyenne, Wyoming. He began a general and family practice in 1966 in Cresco, Iowa. From 1981 to 1982 he was an emergency physician at Medical Center Independence and the Keokuk Area Hospital. In 1982 he became a clinical instructor in emergency medicine at University Hospital and Clinics in Columbia, Missouri. Dr. Nierling had served on the board of directors at the American College of Emergency Physicians' Missouri Chapter since 1985 and was president of the chapter from 1989 to 1991. He was a member of the American College of Emergency Physicians, and the Missouri State and American Medical Associations.

Above reprinted from Missouri Medicine, Jan 1994 with permission.

NEUROLOGY



Leonardo Garcia, MD
Associate Prof., Pediatric Neurology

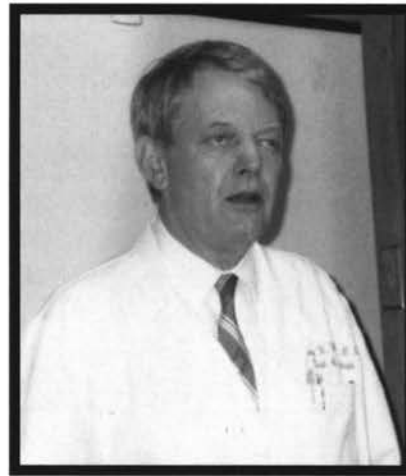

Harry H. White, MD
Professor & Chair, V.A. Neurology



James Dexter, MD
Professor & Headache Guru



Drs. Lim, Sankar, and Rao need Nolan's help with the slide carousel...



Ruby Saulog, MD



Malti Gohel, MD



Mark Stacy, MD
Assistant Professor, Course
Director, MU Alum, Philosopher...

Mark Stacy's Residency Survival Pearls:

- 1) you will be depressed, so expect it.
- 2) learn to punish people
- 3) make friends who have blind trust funds.

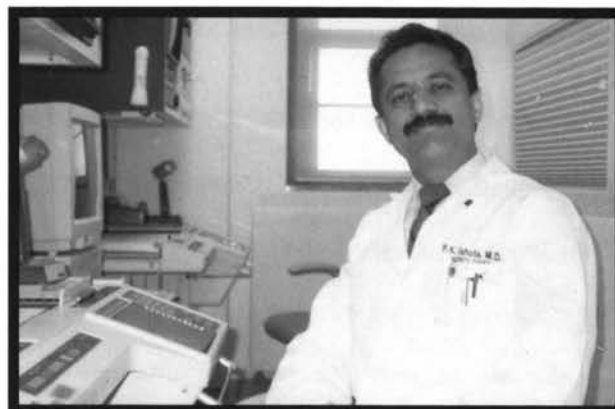

RIGHT: Dr. Sahota in the
Neurophysiology lab.



Another smiling face in the
Department of Neurology

INTERNAL MEDICINE



Back Row:

Alfredo Jimenez, Fady Nassif, Georges Bou-Samra, Don Park, Muhannad Al-Kilani, John Higgins, Kevin Dishman, Harparatap..

Center Row:

Sreekanth Daranam, Chandra Dommmaraju, Namita Sood, Rolan Pascual, Anurag Misra, Vijay Chilakamarri, Vivek Jain,...

Front Row:

Mutha Krishnan, Raed Aquel, Mudhuri Trivedi, Darshana Shanbhag, Ameena Anees, Moez Premji, Dr. Patterson, Dr. Weber,...

INTERNAL MEDICINE



Sandhu, Syed Jilani, Hyder Jamal, Julie Anne Stansfield, Zubair Khan, Uzma Khan, Tanveer Malik, Sajjad Habib, Asif Akhtar.
Sherjab Jacob, Melissa Frame, Monika Prost, Pamela Dowling, Tabassum Chowdhury, Raj Styanarayana, Jacob Joseph.
Dr. Everett, Naveek Malik, Tasneem Bader-Omarali, Anshu Bhatla, Tahira Saifuddin, Nasir Shahab, Patricia Guerrero.

INTERNAL MEDICINE



Doak Phillips makes a teaching point as an M-3's synapses try desperately to fire...



LEFT:
You can trust me, I'm a doctor.



Ameena digs through a V.A. chart desperately seeking a legible assessment & plan.



"just keep smiling, and try not to look suspicious"

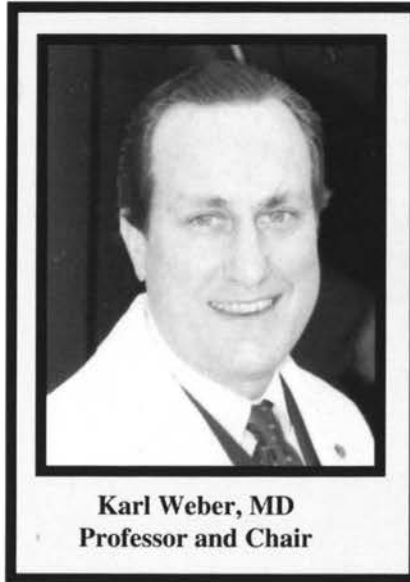

**Karl Weber, MD
Professor and Chair**



Not just a healer, but a lover of flora and fauna of all species.



LEFT:
"Now what the hell do you want?"

RIGHT:
John has Hyper-beeper-osis...



After a while, you get really good at pretending you're having fun.



LEFT:
Name the Lesion



Patricia is amused by something...



Melissa poses by the porta-potty

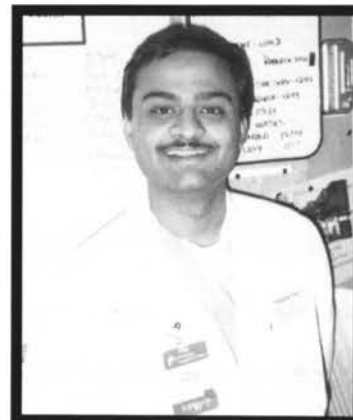

"Yes, Sir, I have absolutely everything under control!"



Not so fast, Dr. Marrienfeld,....

INTERNAL MEDICINE



"Another Hit!
You've GOT to be kidding!"



"Because I said so,
That's why."

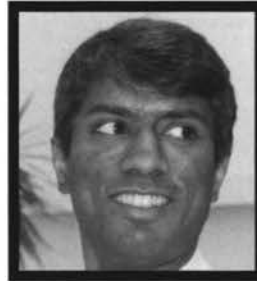

"I don't know about you
guys, but I'm outta here!"



"I told you, You've got to
quit taking everything so
seriously"



LEFT:
"Okay,
but I'm
doing it
because I
want to,
not
because
you told
me to!"



LEFT:
"Back when I
was a resident,
we walked
three miles
through the
snow and took
call every
single night..."

INFECTIOUS DISEASE



Gordon Christensen, MD
Professor



E. Dale Everett, MD
Professor and Director

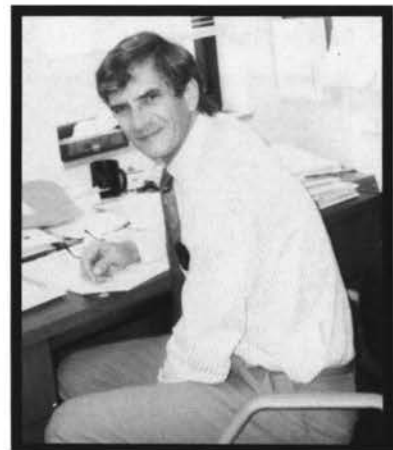

William Salzer, MD
Associate Professor

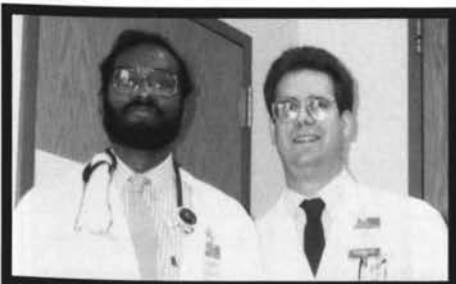

Nat Ratnasamy, MD and Will Roland, MD



Butch Cassidy and the Sundance Kid



Skip McKnelly, MD keeps feisty M4s
under control

DERMATOLOGY



Dana Ward, MD
Assistant Professor

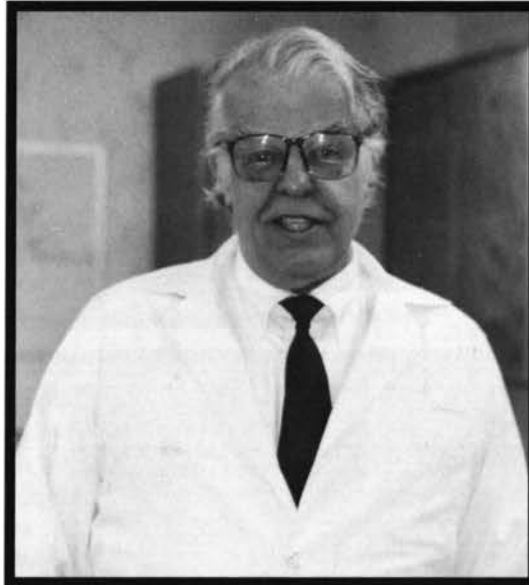

P.C.A.
(Phillip C. Anderson, MD)
Professor and Director



Susan Zurowski, MD
Assistant Professor



Miriam Shatley, MD

Not Pictured:
Karen Eshraghi, MD,
Rosalind Freas, MD, and David Gaston, MD



Margaret Litwin, MD

RIGHT:
David
Clark,
MD
Associate
Professor



LEFT:
Ron Swinfard,
MD,
Assistant
Professor,
with Byron
Limmer,
MOHS Fellow
and Rachel
Dotson, MD

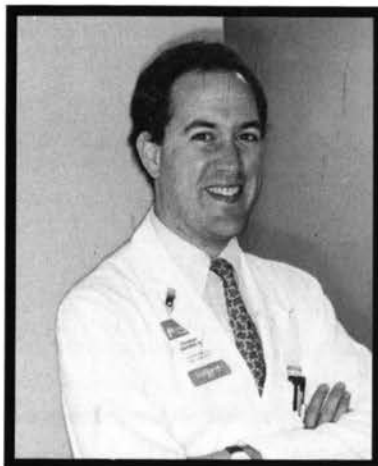

40 Christopher Snyder, MD



Karen Zanol, MD
Assistant Professor



Steve Musick, MD

PULMONARY



Frederick Bode, MD



R. Phillip Dellinger, MD
Director



Patrick McKillion, MD



Wayland McKenzie, PhD



John Yanos, MD
Deliriously wanders into the SICU.



Mir Shuttari, MD



Carlos Sanchez, MD
Fellow



Jeff Verhey, MD
Fellow

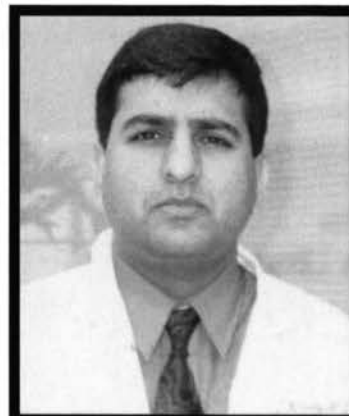

Rajeev Narang, MD
Fellow

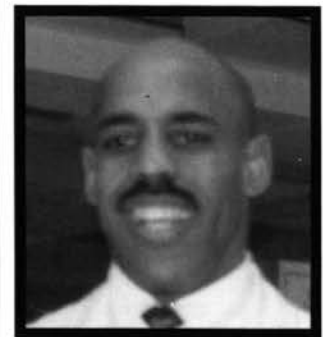

Michael Johnson, MD
Fellow

NOT PICTURED:

Vlassi Baktidy, MD, Fellow
Brian Brown, MD, Fellow

Julia Lunberry, MD, Fellow

Anthony Vacca, DO, Fellow
Rolando Rumbaut, MD, Fellow

CARDIOLOGY



Daniel Villareal, MD
Associate Professor



Gregory Flaker, MD
Associate Professor



Karl Weber, MD
Director



Brent Parker, MD
Professor Emeritus

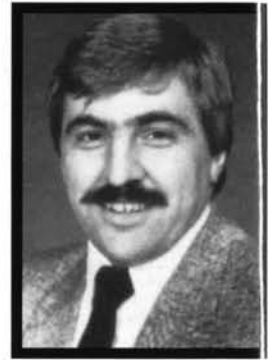

Richard R. Webel, MD
Associate Professor



Donald Voelker, MD



Tshiswaka Kayembe,
MD



Imam Tjahja, MD



Guoping Zhou, MD



Darla Hess, MD

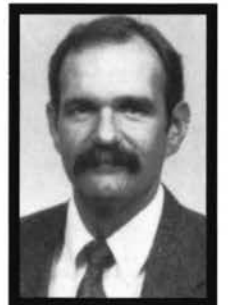

Patrick McLaughlin,
MD



Rakesh Sharma, MD



Vibhuti Singh, MD



Robert Meyers, MD



Yao Sun, MD, PhD



H. K. Reddy, MD

CARDIOLOGY FELLOWS

(Not Pictured)

Godfrey Achilihu, MD
Kul Aggarwal, MD
John Bartolozzi, MD
Ernesto Chua, MD
Makesh Gupta, MD
Ahmed Habibullah, MD
Walid Hassan, MD
Alireza Jafari, MD
Ali Jaffar, MD
Ameer Kabour, MD
Ravi Kethireddy, MD

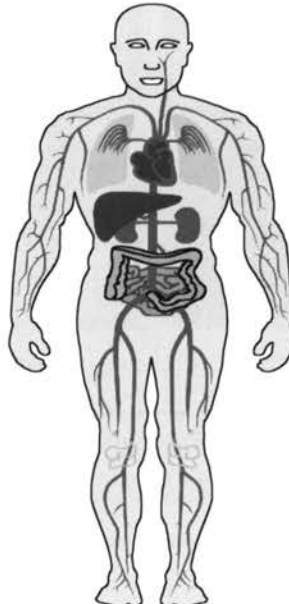

MORE CARDIOLOGY FELLOWS

Attila Kovacs, MD
Mike Kreager, MD
Gloria Mays, MD
Iqbal Omarali, MD
Rajendra Patel, MD
Roa Podapoti, MD
George Pulos, MD
Mohammad Rizvi, MD
Bhaskaran Sreekumar, MD
Krishnaswami Sriram, MD
Amir Taraben, MD
Venkata Thondapu, MD

IMMUNOLOGY / RHEUMATOLOGY

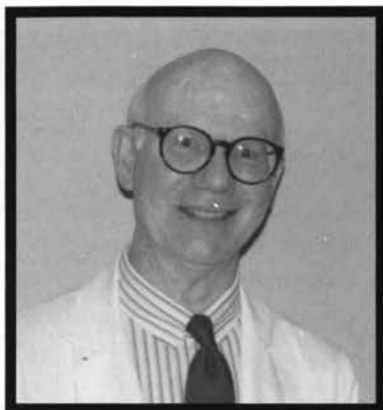

James Cassidy, MD
is out to round up the usual suspects

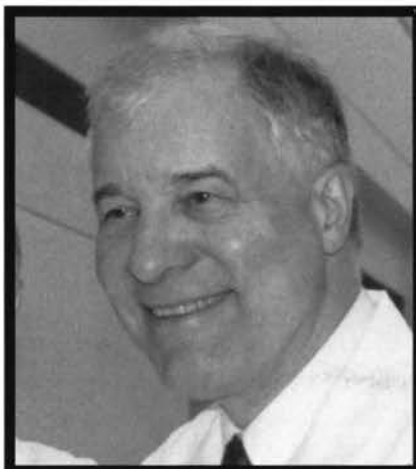

Gordon Sharp, MD
Director



Robert Hoffman, DO



Sara Walker, MD

Not Pictured:
John Hewett, PhD
Helen Mullen, PhD
Nancy Brown, DO, Fellow



Geetha Komatireddy, MD



Frank O'Sullivan, MD

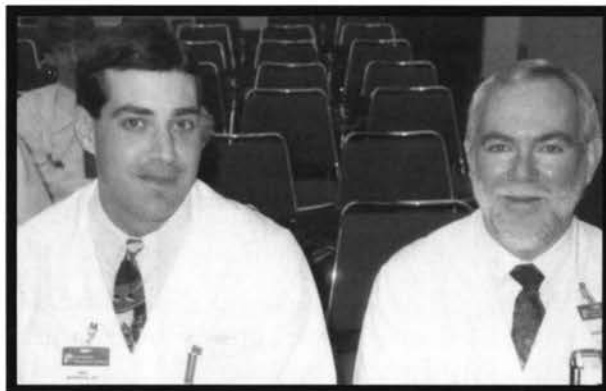

Matt Morrow and David Weidensaul, Fellows
await another fascinating conference



Robert McMurray, MD

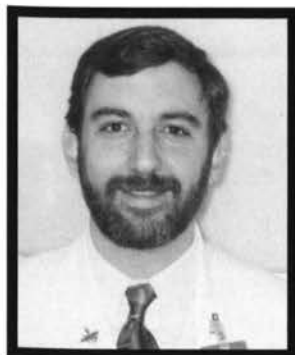

David Swift, MD, Fellow



Ketan Patel, MD, Fellow



Robert Leitch, MD, Fellow



Margaret-Mary Holyst,
MD, Fellow

GASTROENTEROLOGY

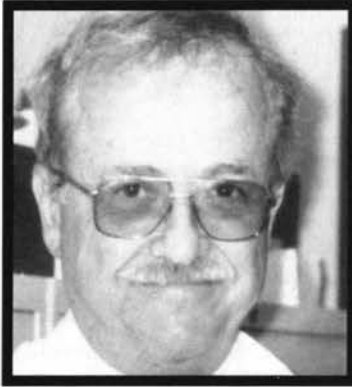

James Butt, MD



David Schneider, MD, fellow; Shariq Afridi, MD and John Marshall, MD, Interim Director



James Barthel, MD



Juan Pineda, MD, Fellow



Raghujit Singh, MD, Fellow

NOT PICTRUED:
Paul King, MD
Robert Graveline, MD, (Fellow)
David Brown, MD (Fellow)



Jeanette Newton, MD, Fellow



Jadi Diab, MD, Fellow

NEPHROLOGY



Oleg Georgiev, MD, Fellow, Sunder Lal, MD, Brajesh Bhatla, MD, Fellow



Karl Nolph, MD, Director



Hariprasad Trivedi, MD, Fellow, Pranay Kathuria, MD, Fellow, Zbylut Twardowski, MD, Richard Jensen, MD, Fellow

RIGHT:
John Bauer, MD takes an important call



LEFT:
Ramesh Khanna, MD

RIGHT:
Sunder Lal, MD



RIGHT:
Pranay Kathuria, MD, Fellow



ENDOCRINOLOGY



George Griffing, MD
Director in persistant manic phase



Thomas Burns, MD
Great teacher & wine connoiseur



David Klachko, MD
asks: *How sick is the patient ?*



David Gardner, MD
Computer Jock



Susan Allen, MD, PhD
Nicest pimper ever



Rod Stout, MD, Fellow
*Students pimping the fellow
is a dangerous game*

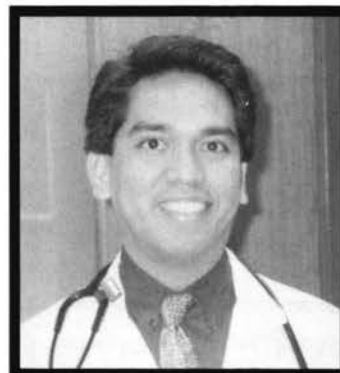

Gabriel Jasul, MD, Fellow
Just a super nice guy

HEMATOLOGY / ONCOLOGY



LEFT:
Michael Perry, MD
Nellie B. Smith
endowed
Chair of
Oncology
and Ace
Detective

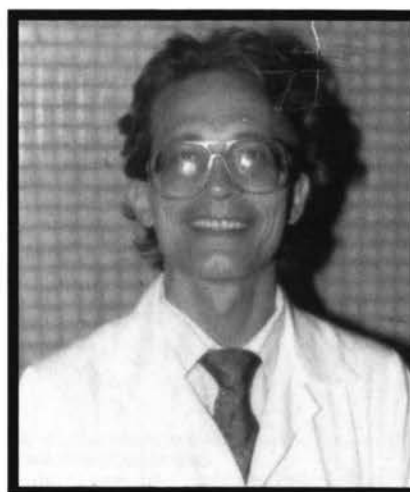

RIGHT:
Donald Doll, MD
Professor
and
collector
of fine
cowboy
boots

NOT PICTURED:
Medhi Farhangi,
MD
Magdy Bottros,
MD
(fellow)

OBSTETRICS AND GYNECOLOGY



Renee Boulicault, R-1; Erik Wait, R-3; Paul Gisi, R-2; Leslie Sackschewsky, R-4

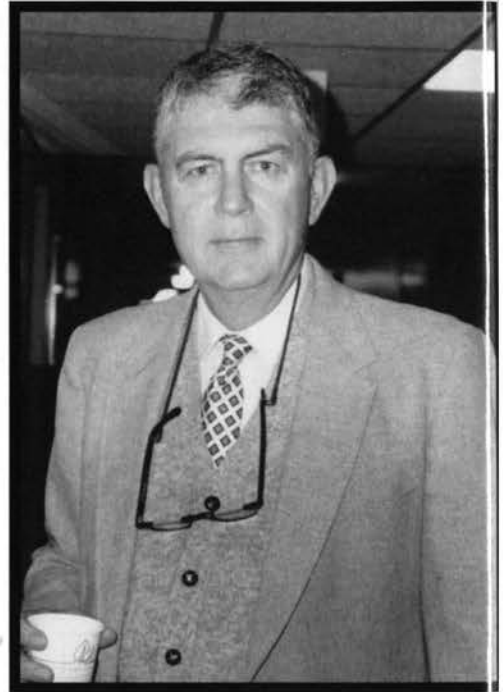

James Daly, MD Professor and Chair



Wayne Hess, MD



John Cassels, MD



*James Sowash, MD
course director and student favorite*



Bill Smith, R-4



Gina Muscolino, R-2

LEFT:
Lorraine
Fincke-
Dodson,
R-4

Not Pictured:
James Green, MD
Lisa McCluskey, R-2
(she was camera shy)
Lydia Keisler, R-1



George Fuchs, MD



Nancy Miller, MD



Lynn Puckett, R-3.....

OBSTETRICS AND GYNECOLOGY

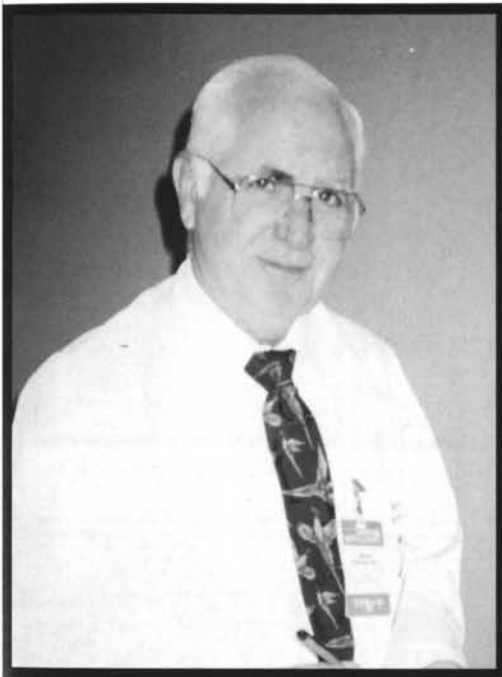

William Griffin, MD, Professor Emeritus



Joe Jacob, MD
circa 1988

Did You Know...

Joe Jacob attended University of Missouri School of Medicine, graduating in 1983
Did his OB/GYN residency at the University of Missouri
Did his Gynecologic Oncology fellowship at MD Anderson in Houston, Texas
Returned to Mizzou last year to head Gynecologic Oncology at Ellis Fischel.
Is married to Dana Ward, MD (dermatology), also an MU alum
Was a former MUTant leader and is responsible for the awe-inspiring and motivating 1983 PLAYMUT (check it out...we have a few leftover copies for sale)
Is this year a proud patron of the 1994 MUltation. Thanks, Joe!!

Did You Know...

Mark Grant lists Columbia, MO as his home town and did his undergraduate studies at Mizzou
Also attended the University of Missouri School of Medicine, graduating in 1986
Did his OB/GYN residency training at the University of Missouri
Did his Maternal Fetal Medicine fellowship at the University of Texas - San Antonio
Was a 1994 recipient of an MSAC Excellence in Education award in his first year as teaching faculty. Congrats!!
Is holding a beer in 2 out of 7 of his photos in the 1986 MUltation and has a blond wig on in two others
Was not a proud sponsor of this year's book, but we're sure he will be next year!!!!



Mark Grant, MD
Circa 1988



Scott Snyder, MD



L. L. Cool J., MD



Cindy Harmon



Kathy Sharpe, PhD



Susan Winkelmann, MD



Mary Beth Benton, MD

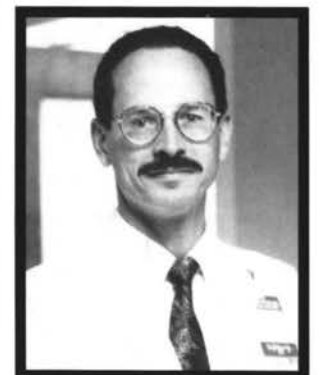

John Gay, MD



and Kathy Costic, R-1



Rick Fraser, MD



Yum, Yum, Erik loves cafeteria Grub!



Alfred Llorens, MD

OPHTHALMOLOGY



John Cowden, MD
Chair



Theodore Wills, MD

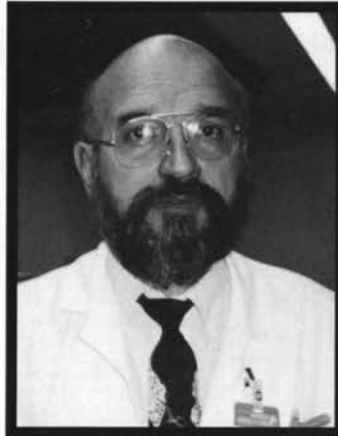

Joseph Giangiacomo, MD

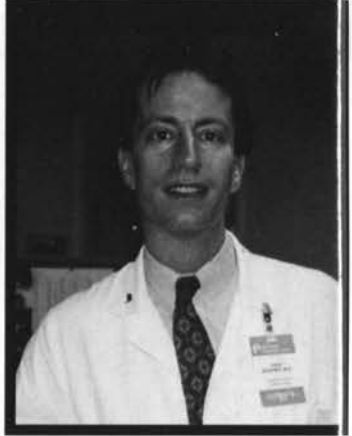

Kevin Blinder, MD



Lenworth
Johnson,
MD
*Consults
his Wall
Street
Journal
daily*



Scott Allen, R-3



Carolyn Elias, R-4



ABOVE: *The consequences of over-specialization...Mark Cox, R-3 and Kevin Blinder, MD, can't remember if OD is the right or left eye....*



Rob Jeffries, R-2, and Paul Botelho, R-2



Shahin Shahinfar, R-4

RIGHT: Lance Bergstrom, R-3:
have I got a history for you!!

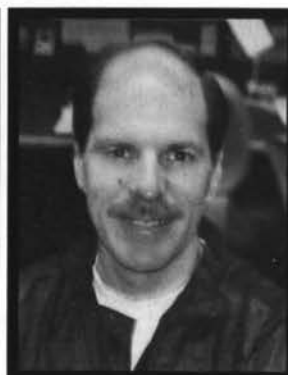

LEFT: Frank Rieger
Cornea Fellow

NOT PICTURED:
David Dueker, MD
Leo Landhuis, MD
Todd Gould, R-2

PHYSICAL MEDICINE & REHABILITATION



Mike Acuff, MD

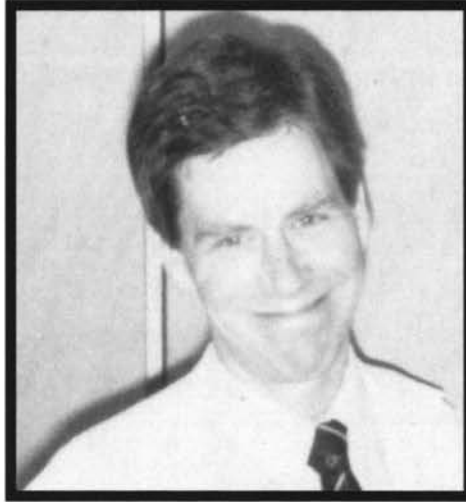

Robert Conway, MD

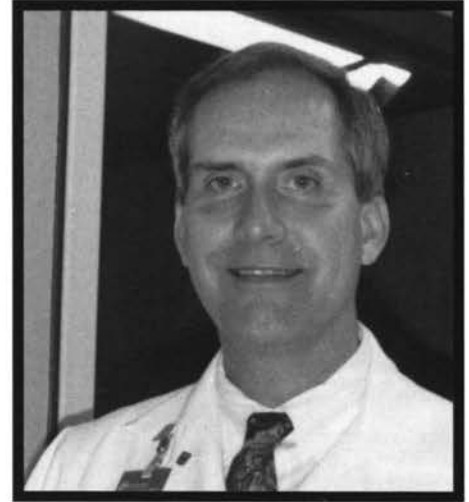

Jon Rupright, DO



Martin Childers, DO, R-4



Mark Starr, MD, R-4

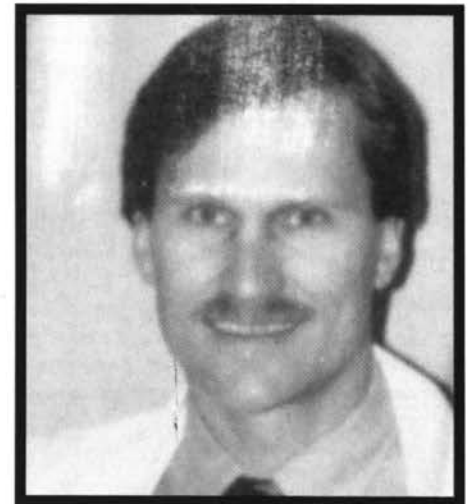

Robert Biedermann, DO, R-3



John Brannan, MD, R-3

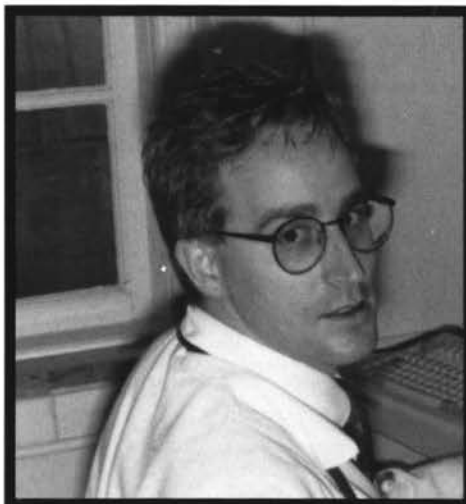

Mark Hinrichs, MD, R-3

NOT PICTURED:
Steve Gnatz, MD
Renee Moss, MD
Randall Smith, MD
Henry Stonnington, MD, Chair
Edward Wright, MD

Jennie Gorham, DO, R-2
Ranjit Gowda, MD, R-2
Charles Law, MD, R-2
Laura Ottaviani, DO, R-2
Dan Wilson, DO, R-2
Edward Woods, MD, R-2

PSYCHIATRY



Thomas Eppright, MD and Stephen Soltys, MD



Bernard Beitman, MD, Chairman

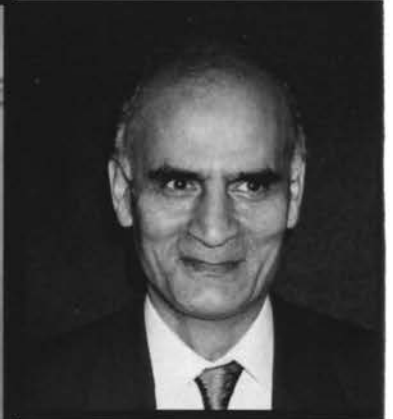

Javad Kashani, MD

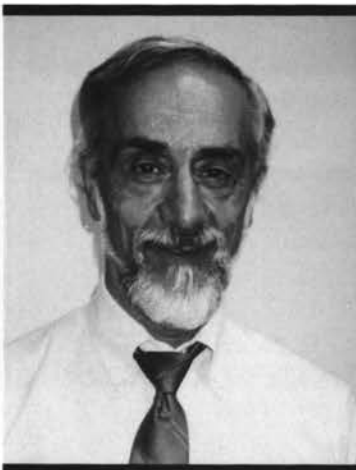

Joseph Lamberti, M.D.

Not Pictured:
 Bruce Harry, MD
 Lee Ann Kelley, MD
 Alejandro Natividad, MD
 James Slaughter, MD
 Earl Dick, MD
 John Higdon, PhD



Niels Beck, PhD



Robert Jones, M.D.



Jeffrey Thiele, MD



Madan Mohan, MD, Anna Coleman, Jose Jamena, MD



Cheryl Hemme, MD and Pam Miller, MD



John Patterson, M.D.



Usha Manusmare, M.D.



Theodore Henrichs, PhD



Armando Favazza, M.D.



Karen Soltys, M.D.

PSYCHIATRY



Front: Praveen Nimmagadda, R-3; Walter Anderson, R-4 (child psych); Houshmand Rezvani, R-2; Mohammad Bhaghani, R-2; Manisha Lele, R-2; Archana Aggarwal, R-3; Jyotsna Nair, R-4 (child psych); Dorcas Anderson, R-2.
Back: Syed Rashid Mumtaz, R-1; Patric Darby, R-1; James Sales, R-1; Ruben Bravo Valverde, R-1; Nicodemus J. Garcia, R-4.



Satnam S. Mahal, R-4
(child psych)



Vishwanath Gundur, R-5
(child psych)



ABOVE--

Front: Gabriell Peton, R-1; Dorcas Anderson, R-2.
Back: Rashid Mumtaz, R-1; John Zimmerscheid, R-2; Andre Rivera-Guevara, R-1; James Sales, R-1.



Syed Husain, MD



LEFT
Big
Fun
on 2N

Not Pictured:
Iyad Khreis, R-2; Rigardy Munoz, R-2; Jill McNaul, R-3; Katherine Kostal, R-4.

RADIOLOGY



Robert Churchill, MD



Jimmie Dean Coy, MD

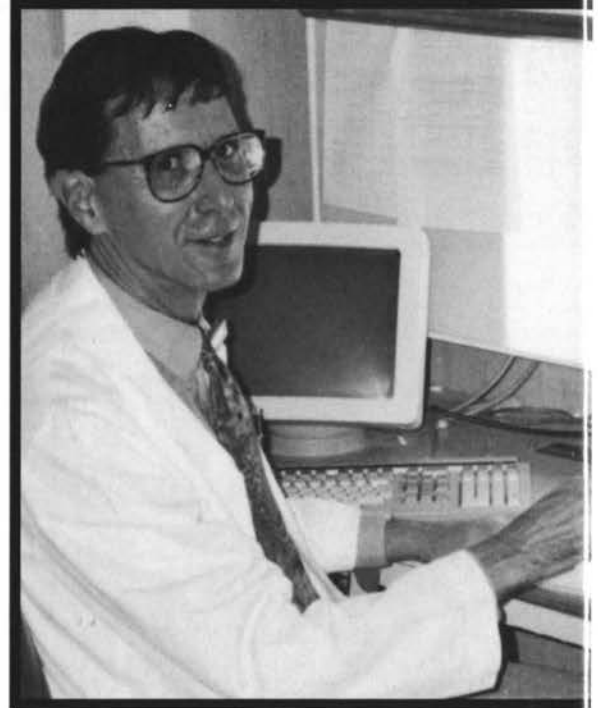

Dr Clive Levine and...



ABOVE: Dr. Terry Hoyt

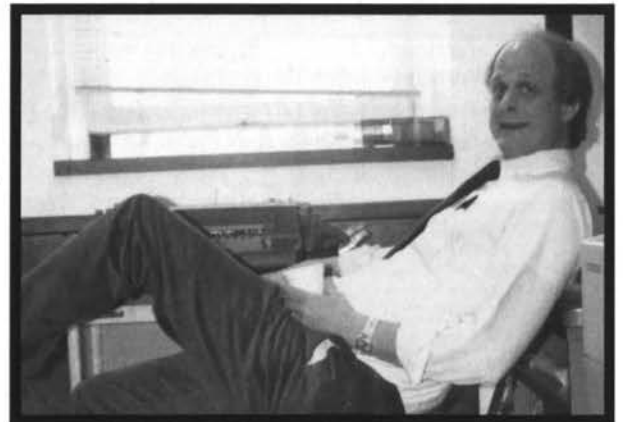

Geoffrey Beale displays his no-nonsense approach to life

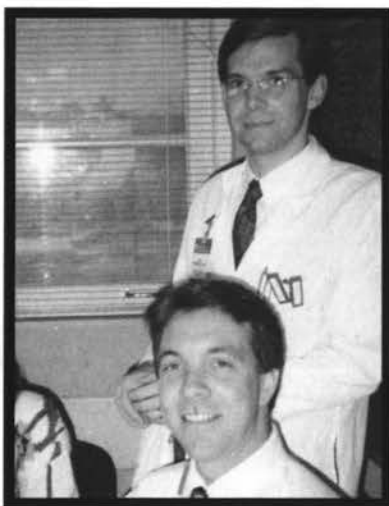

*Mark James, MD and
John Fiederlein, R-3*



P. T. , MD, R-3



Terry Elwing, MD



Don Breit, R-2

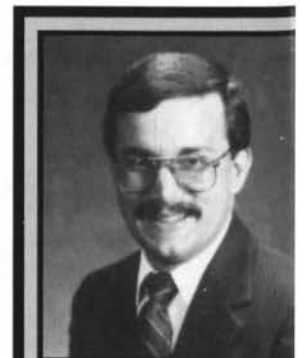

*Joey Hassien, R-4
circa 1990: respectable*

*Not Pictured:
Richard Holmes, MD
Mary Lee, MD
Kimithia Trethewey, MD*

RADIOLOGY



Dr. Willie Miller, R-1



Alan Hillard, MD



Ray Cope, MD



ABOVE:
*Tricia Smith, R-2 &
Joan Tomanek, R-2*

LEFT: *Amolak Singh, MD*

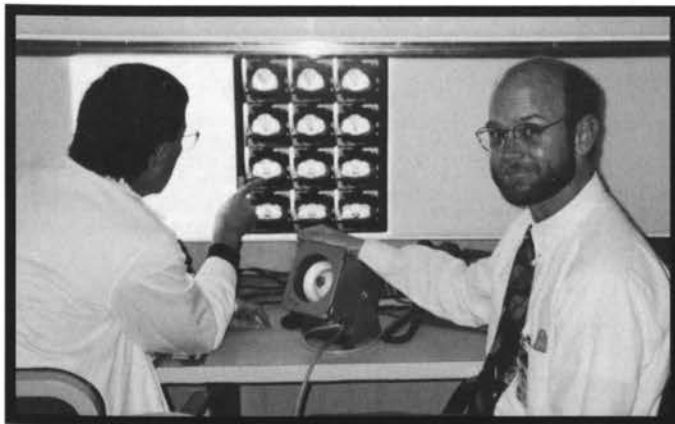

David Stoppenhagen, R-4, has a hard time paying attention !!



Not Pictured:
*Richard Reber, R-1
Tim Roses, R-1
Lisa Hinckley, R-1
Eric Justin, R-4*

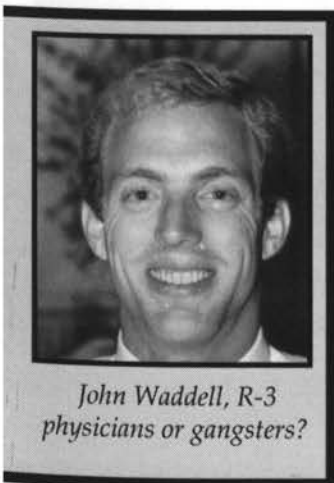

*John Waddell, R-3
physicians or gangsters?*



Mark Monroe, R-4



Richard Seeger, MD



Fabio Rodriguez, MD
53

Department of Surgery

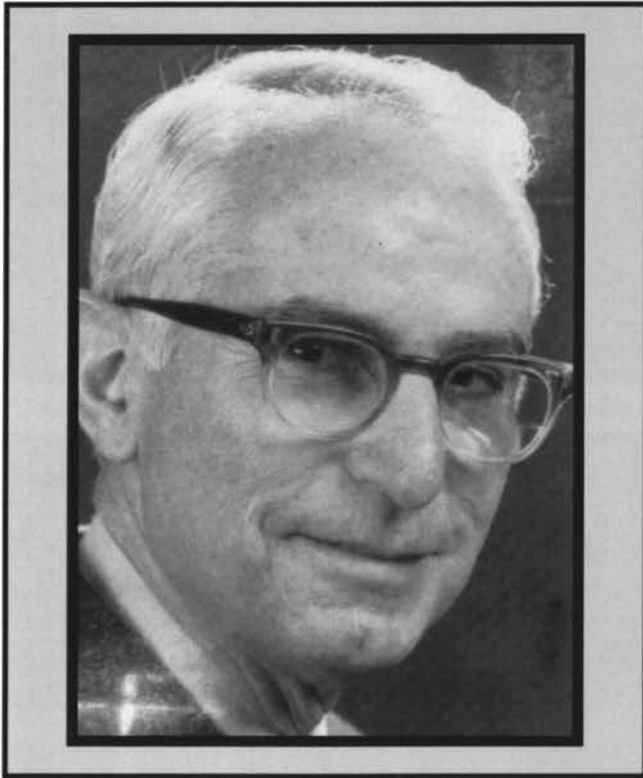

Donald Silver, M.D.

Chairman

W. Alton Jones Distinguished Professor
Chief, Division of Vascular Surgery

"Silverisms"

1. The cardiac output to the great toe.
2. The total body potassium.
3. Leriche's syndrome.
4. The half-life of aspirin.
5. The molecular weight of heparin.
6. The clotting factors.
7. The anatomy of the Circle of Willis.
8. The pO₂ of umbilical artery blood.
9. Laplace's Law.

Division of Vascular Surgery



W. Kirt Nichols, M.D.,
Professor
photo circa 1981



Dr. Don Silver
Chief



Donald Spadone, M.D.,
Associate Professor

Not Pictured:

Drs. John Adams and
Michael Kitka, Fellows.

Division of General Surgery

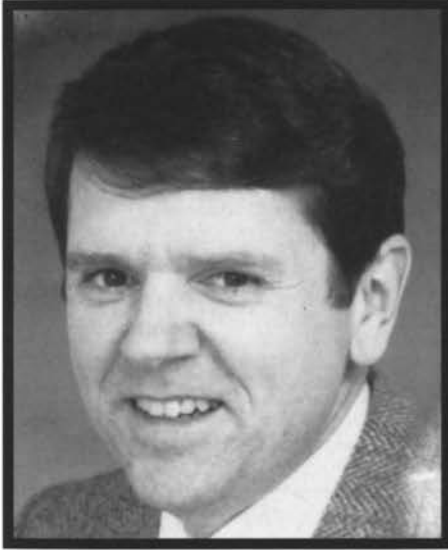

Michael H. Metzler, M.D.
Chief of General Surgery
and the
John Gordon Distinguished
Associate Professor



circa 1989



"No, this is not a good
medical student case."



"How do you want
me to cut the knots
- too long or too
short?" (above)
"Loy...try to stay
awake." (left)

Division of General Surgery

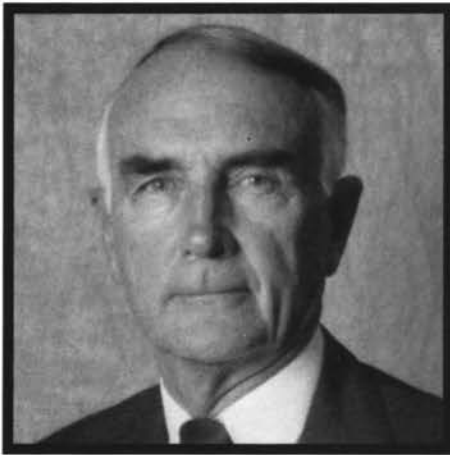

Loren J. Humphrey
M.D., Ph.D., Professor

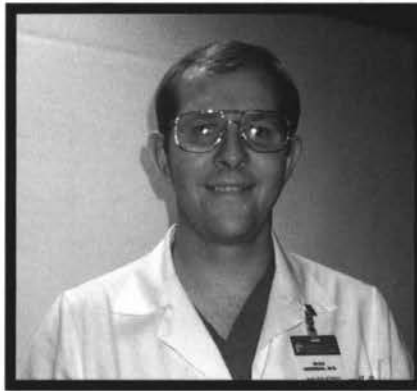

Brent W. Miedema, M.D.
Assistant Professor



Frank L. Mitchell, M.D.
Professor



Mary Alice Helikson, M.D.
Assistant Professor
photo circa 1981



Terry E. Boyd, M.D.
Associate Professor



Debra G Koivunen, M.D.
Assistant Professor
photo circa 1981

General Surgery Faculty not pictured:

Stephen Sugarbaker, M.D.,
Assistant Professor.

Jeffrey O. Phillips,
Pharm. D.,
Assistant Professor.



Edward Ege
Pharm. D.
Clinical Specialist



*"Let me tell you about the
nutritional requirements
of the patients in the SICU..."*
-- M. H.

Division of General Surgery

Chief Residents

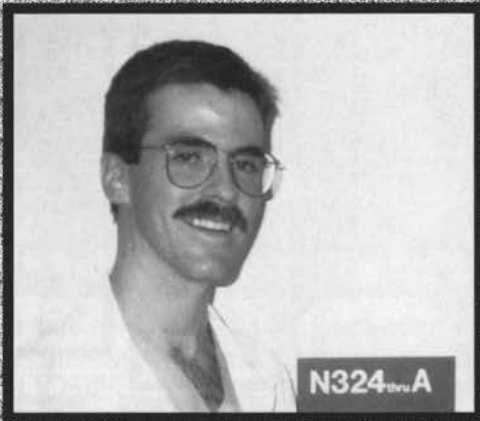

Ron Richmond, M.D.,
Chief Resident



Kenneth Larson, M.D.,
Chief Resident

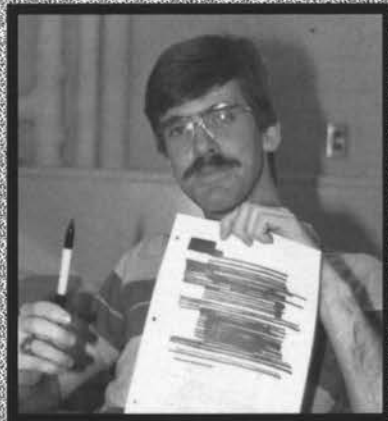

Ron circa 1986 as an M2.



Ken circa 1988 as an M3.



Tina Palmeri, M.D.,
Burn/Critical Care Fellow



Mike Scheer, M.D.,
Critical Care Fellow

Division of General Surgery

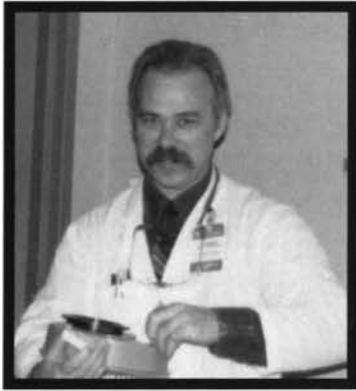

Rod Courson, M.D., R4
"I'll teach the students once I figure out this slide carousel."



Kurt Cox, M.D., R4
"Wes, he only weighs 700 pounds..."



Paul Yazdi, M.D., R4
"Let me get a clean coat before you take my photo."



Steve Hughes, M.D.
R3, Plastics
"I'll get that page once I finish this coffee."



Patricia Barker, M.D.
R2, General Surgery



Michael Lasky, M.D.
R2, General Surgery,
photo circa 1992.



Linda Pia, M.D.
R2, General Surgery



Loy Pucket, M.D.
R2, General Surgery,
photo circa 1992.

Interns:



"As interns, we never saw the sun!" according to Chief Resident Dr. Metzler in 1981.

R2s not pictured:

Joe Grzeskiewicz, M.D.,
Plastic Surgery;
Terry Phillis, M.D.,
Urology;
David Wilfong, M.D.,
Urology.



Enjoying a little sun, Drs. Gregory Bazell and Mark Smith clearly do not have enough work to do.

Division of General Surgery



Mark Boschert, M.D.
circa 1993



Marci Bothwell, M.D.

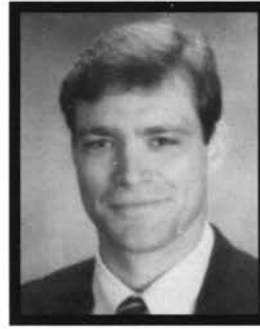

Stephan Craig, M.D.
circa 1993



William Senf, M.D.
circa 1993



Steven
Stokesbary, M.D.



Steven Schafer, M.D.

**Interns not
pictured:**

Crystal Knierim
and
Frank Moussa



Neil
Van Leeuwen, M.D.



Charles
Wetherington, M.D.

Division of Oncologic Surgery



David Ota, M.D.
Professor
Medical Director of Ellis Fischel



Joseph Skibba, M.D., Ph.D.
Associate Professor

Ellis Fischel Cancer Center



Not pictured:
Steven Standiford, M.D.
Assistant Professor

Division of Cardiothoracic Surgery

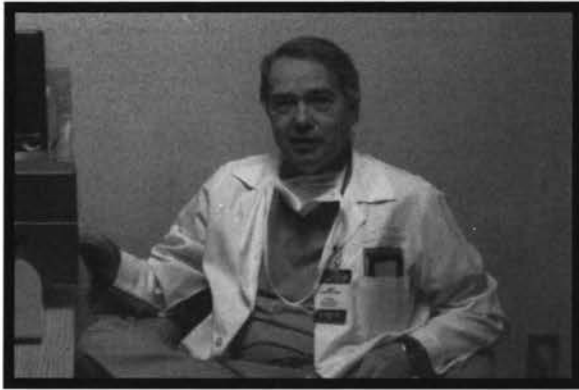

Jack Curtis, M.D.
Professor and Chief

Not pictured:

Todd Demmy, M.D.
Assistant Professor,
Marvin Ewy, M.D.
Fellow,
Staton Autry, M.D.,
Fellow.



Joseph Walls, M.D.
Professor



Richard Schmaltz, M.D.
Assistant Professor



Norman
Caron, M.D.,
Clinical
Instructor,
abides by one
of the Surgeon's
mottos:

***eat when
you can...***

Division of Neurological Surgery

Ted
Colapinto,
M.D.,
Assistant
Professor



John Oro, M.D.
Associate Professor, Chief, and
Newton Fanatic



David
Jimenez,
M.D.,
Assistant
Professor



Residents: Drs. Scott Gibbs, Rick
Boyer, Charles Wetherington, and
Charles Bondurant, Chief Resident.



Martha
Cabeen,
M.D., R5



Dr. Mike Paul, R4, demonstrates
his multi-disciplinary approach
to neurosurgery.

Division of Urologic Surgery

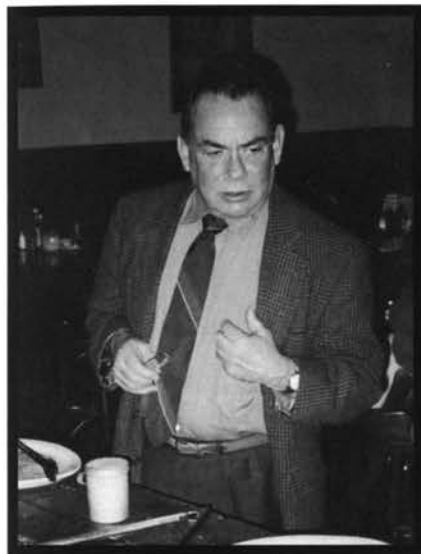

Gilbert Ross, Jr., M.D.
Professor, Chief,
and Master Chef. (left)

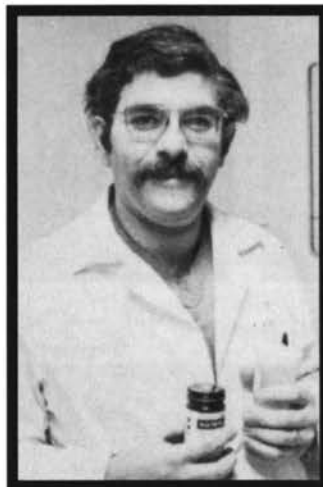

Stephen Weinstein, M.D.,
Associate Professor
circa 1981



Dana Weaver, M.D.,
Associate Professor,
enjoys her 1981 copy of
the MUtation. (left)



Lance Pickard,
M.D.,
Chief Resident,
Texan,
and
sphincter
salesman.



Scott Michener, M.D.,
R4 and Oklahoman.

Not pictured:

Mike Severence,
M.D., Chief Resident
and Music Fanatic;
Lou Anglo, M.D., R5;
Mike
Yordy, M.D., R4;
and
Mike
Callister, M.D., R3.

Division of Plastic Surgery

Chief Residents:



Dion Chavis, M.D.



Matt Concannon, M.D.



Charles L. Puckett, M.D.
Professor
Chief

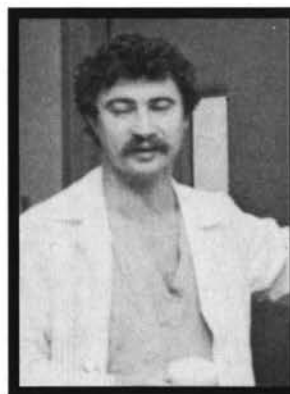

Greg Croll, M.D.
Assistant Professor
circa 1988



Constance Barone, M.D.
Assitant Professor

Division of Orthopedic Surgery



William C. Allen, MD
Professor and Chief



Robert Gaines, MD
Professor



Barry Gainor, MD
Professor



Jeff Anglen, MD
Assistant Professor



Jon Gehrke, MD
Assistant Professor



Eldin Karaikovic, MD
Fellow



Drs. Karl Hamson, R2, Michael Corcoran, R3,
and Jeffrey Parker, Chief Resident.



Steve Apostoles, MD, Chief Resident,
reviews films in Ortho clinic.



Chris Bagby, MD, R4



Mark Blue, MD, R3



Eric Malicky, MD, R2

Not Pictured:

Stephen Miller, MD, R4; James Banovetz, MD, R4; David Moore, MD, R3; and Lance Bear, MD, R2.

Division of Otolaryngic Surgery



William Davis, M.D.
Professor and Chief

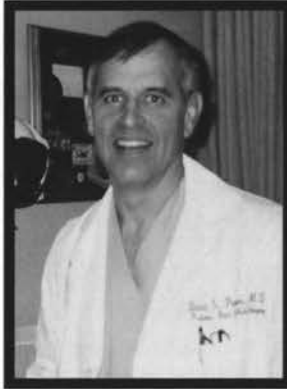

David Parsons, M.D.
Professor



Gergery Renner, M.D.
Associate Professor



Jerry Templar, M.D., Professor,
diligently works in the clinic.



Mahlon Van Deldon, M.D., R2
carries the \$5000 ENT exam box.



Scott Estrem, M.D.
Associate Professor

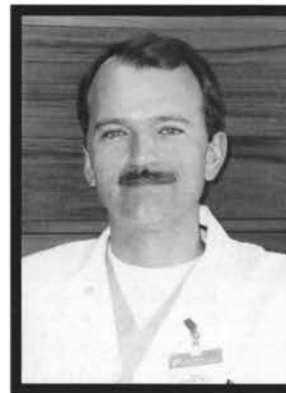

Paul Cook, M.D.
Assistant Professor



Robert Zitsch, III, M.D.
Assistant Professor



Ted Benke, M.D.
Chief Resident



Robert McDonald, M.D.
Chief Resident



Gary Nishioka,
M.D., D.M.D.



Greg Roberts,
M.D., D.M.D.



Rodney
Carrigta, M.D.



David
Chambers, M.D.



Wade
Gaeddert, M.D.



Tim
Herr, M.D.

Not Pictured:

Sam
Vallery, M.D.
and
Byron
Mullins, M.D.

Faculty



Candida



MSAC



1993-94

Standing: Stephen Maxwell, Steve Hunsley, Sandra Hecht, Mary Beth Bange, Sarah Vogel, Tim Staed, Joel McKinsey, David Rudman, Blaine Easley, Shaban Nazarian, Greg Schneider, Sam Hughes, Scott Beard, Dan Pinheiro, Kelly Berkbigler, and Joe Johnston.

Seated: Tama Franklin, Amir Jalali, Mark Wakefeild, and Janine Pingel.

Not Pictured: Jocelle Aguhob, Joe Buback, Laura Den Ouden, Tina Drury, Amani Hanna, Sara Holland, Joy Huddleston, Laura Lowry, Andre Mitchell, Ken Ogawa, Lisa Simmons, Steve Tucker, Cairene Williams, and Nancy Witt.

MSAC Officers:

**Mark Wakefield, secretary,
Janine Pingel, chairperson,
Laura Den Ouden, treasurer.**



MSAC



**" Skake's
or Imo's pizza"**
Nancy, Joel, Sarah, and
Dan debate important
MSAC issues.

The Committee Chairs

Mary Beth Bange - Recycling

**Nancy Witt - Medical
Education and Curriculum**

Greg Schneider - Major Projects

**Tama Franklin - Facility
Improvements/ Library**



While Tama, Ken, and Jocelle
discuss the merits of a new MSAC
constitution, others members
hope for a brief meeting.

**Janine, Joel , and Sam anxiously
await for the door to be unlocked
and for the MSAC meeting to start.**



the MUtation

1993-94 Staff



Right: "You mean
this is the only M2 photo?!?"

Below: "Free pizza will surely get
more people to come to the meetings."



*Keep your hands
off of my moonpie!!!*



the MUtation

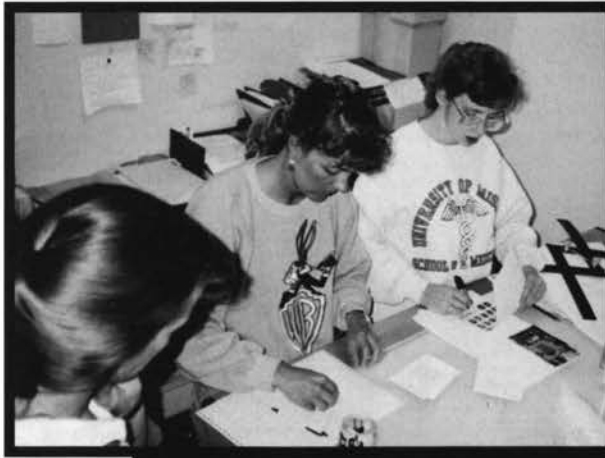

Left: John Sears -- the essential camera man. Below: Sara explains to Hector, "PBL is good because you'll have plenty of time to work on the yearbook."



Above: Denise Zimmer efficiently leads Noel Lumpkin and Anna Scott through the M3 layouts.



Right: Holly Orr is amazed at some of the quotes selected by her classmates.

the Editors



Steve Tucker prepares to sample from the MUtation beer bong.



Dr. Groshong supports the MUtation.



Sara Holland demonstrates cheerful enthusiasm...early in the year.

AMA

American Medical Association - Medical Student Section



Tim Staed and Dr. Maria Evans demonstrate their lobbying tactics.



Doug Hoff swallows the AMA party-line on eating raw shell-fish.



AMSA

American Medical Student Association

AMSA in Columbia (below)
and in Washington, D.C. (right)



Well dressed
and influential,
AMSA
lobbies on
Capitol Hill.



AOA

Alpha Omega Alpha

Class of 1995

Inductees

Tom Baudendistel
 Steven Pepper
 David Rudman
 Dean Smith
 Russel Smith

Resident Inductee

Ted Benke, M.D.

Faculty Inductee

Jerry Templer, M.D.

Faculty Counselor

James Cassidy, M.D.



Back Row: Lindall Perry, John Miles, Barb Howard, Mark Wakefield,
 Sally Bomar, Sherwin Imlay, Jamie Hileman, Ger Lionelli.
 Front Row: Jenny LaBarge, Chris Tocco, Heidi Chua, Nancy Mabe,
 Nancy Witt, and Laura Lowry.
 Not Pictured: Mike Novotney and Caryl Rentz.



FPL

Future Physicians for Life



Back Row: Rick Coats, Eric Byrd, John Boyer, Jim Edwards, John Moll,
 Todd Miller, Chris Chase.
 Front Row: Sandy Hecht, Sarah McElroy, Carolle Silney, Julie Becker, Mary Klix,
 Colleen Powell, Nicole Armaly, Mary Beth Bange.

PSR



Physicians for Social Responsibility

Pictured (left to right):
**Irene Loe, Amy Petterborg,
Joe Buback, and
Kelly Berkbigler.**
Not Pictured: **Ken Ogawa.**

SNMA

Student National Medical Association

Yolonda Bledsoe
Rasheda Hodges
Ray Howard
Jackie McFadden
Andre Mitchell
Suzanna Negussie
James Ojago
Hector Ramos
Nick Sanchez
Lisa Simmons
Helen Thompson
Laine Young



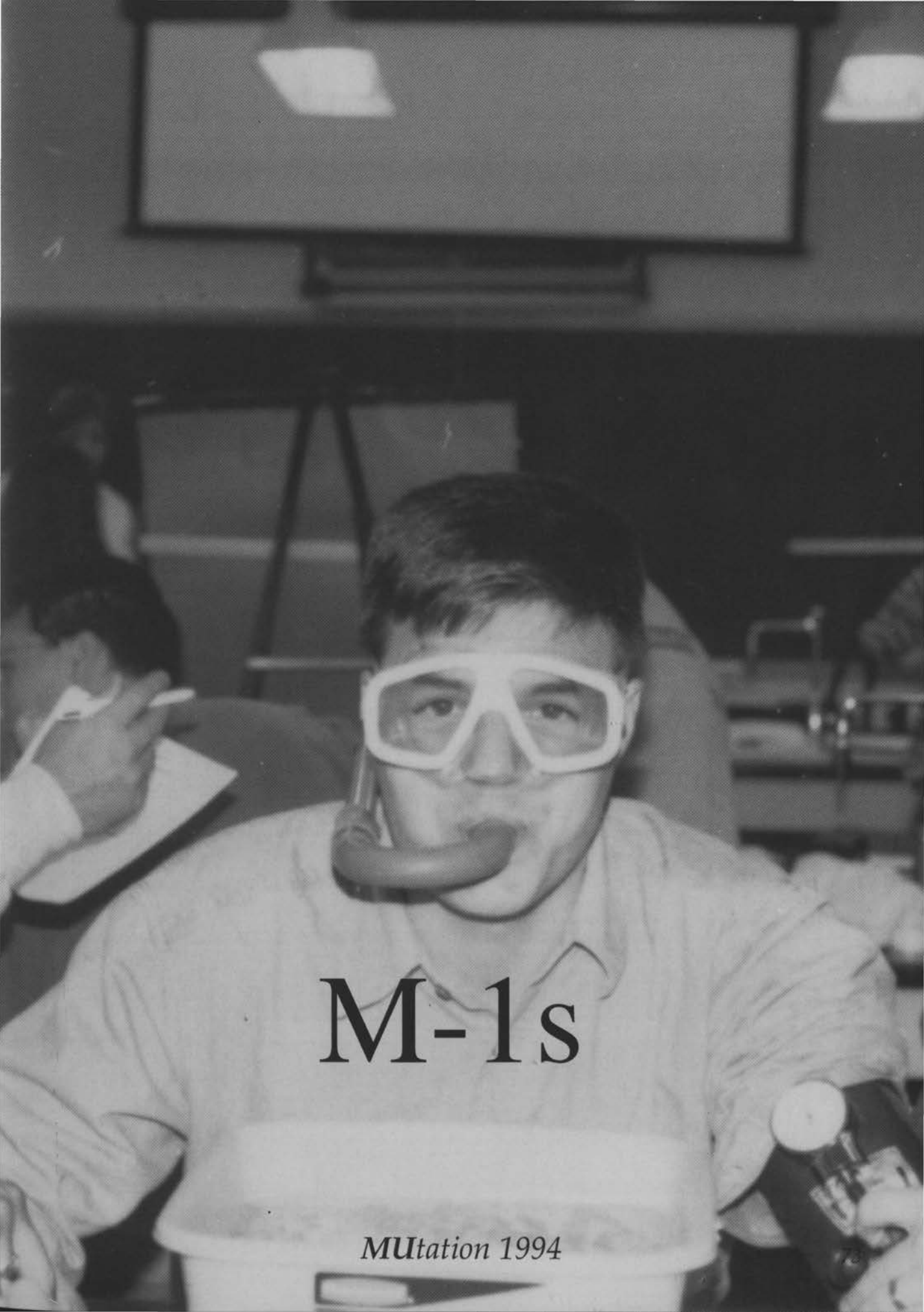

M-1s

*MU*tation 1994

M-1s

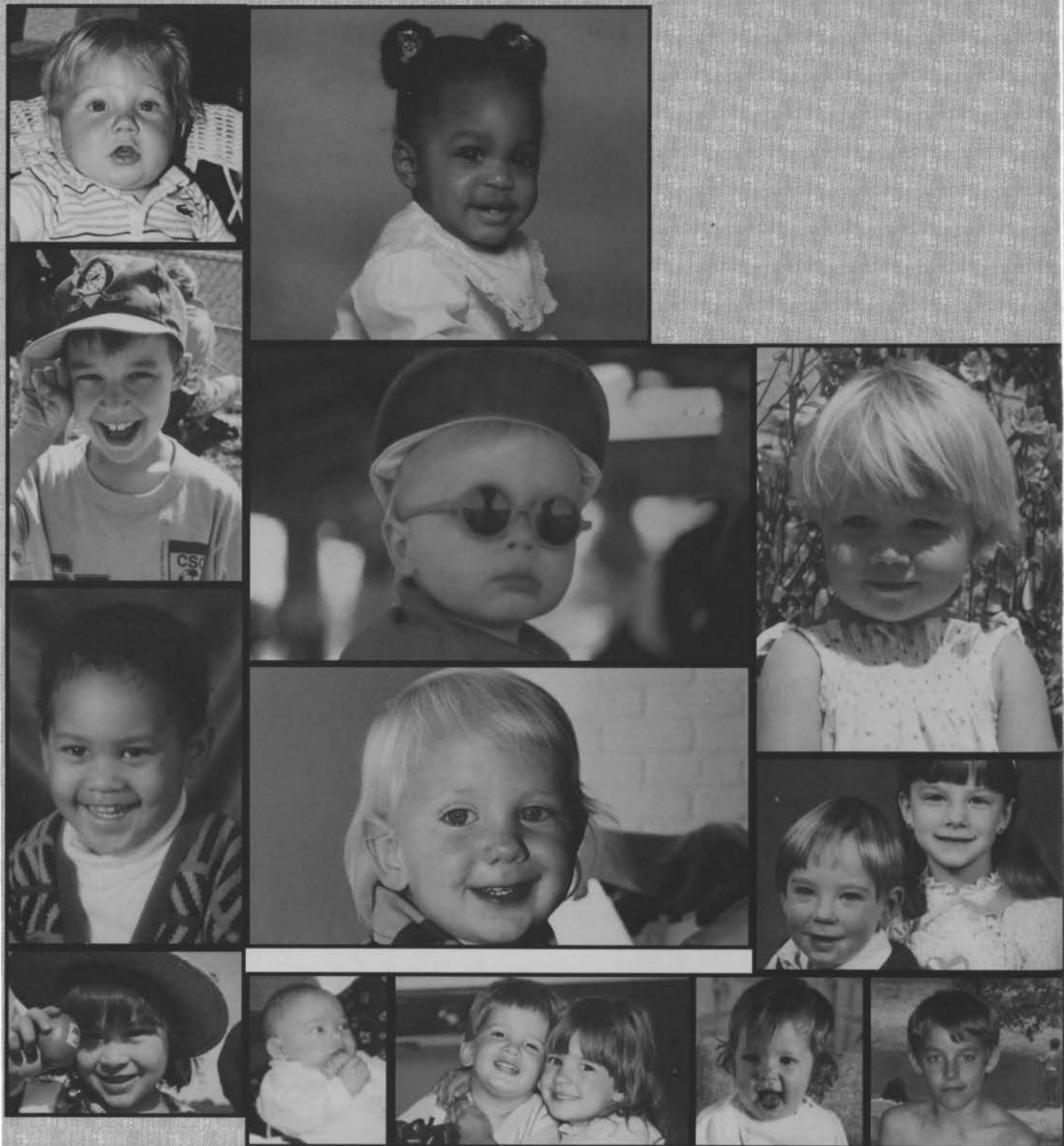

A young.....

M-1s



. but happy crowd

Class of 1997



Darren Alexander



Jay Alexander



Melissa Altom



Nicole Armaly



Alisa Ball



Mary Beth Bange



JoAnn Barbour



Pete Batra



Chris Bauer



Julie Becker



John Boyer



Shawana Branch



Eric Byrd



Michelle Cebuiko



Chris Chase



Rick Coats



Lori Dablemont



Brandon Day



Kim Defenbaugh



Sara Diiger



Pamela Dowell



Tina Drury



Jim Edwards



Monica Eigelberger



Miguel Estevez



Allison Felton



Holly Fleming



Patrick Gilbreth



Dannie Gipe



Steve Haas



Michelle Harrison



Sandy Hecht



Chris Hey



Rodd Hillard



David Hockman



Tami Hopkins



Ray Howard



Theresa Hughes



Rob Irwin



Amir Jatali



Rob Jensen



Tiffanie Johnson



Michael Jones



Mary Klix



Melissa Kouba



Angie Landers



Matt Lavalle



Maorry Lee

Class of 1997



Lol Leonard



Rob Lin



Christina Litherland



Irene Loe



Pranav Loyalka



Michael McCullough



Sarah McElroy



Jackie McFadden



Todd Miller



Dre' Mitchell



John Moll



William Moore



Patrick Mullins



Craig Naugle



Paula Nelson



Wally Parham



Brandon Parkhurst



Amy Petterborg



Tamara Phelps



Roy Phillips



Nyk Pidhorodeckyj



Colleen Powell



Hector Ramos



Rustico Ramos



Deborah Rasmussen



Brian Rekus



Miguel Rivera



Nick Sanchez



Ann Saunders



Alle Scholes



Matt Schumer



Carole Silney



Sommer Sirawan



Jane Anne Soeaker



Susan Stackelhouse



Matt Stelzer



Dan Strode



Mark Sullivan



Kris Sunkara



Matt Taylor



Christy Tharenos



Tom Theiss



Damon Thomas



Helen Thompson



Park Triplett



Ric White



James Williams



Laine Young

Class Leaders



Amir Jalali
President



John Moll
Vice President



Nichole Armaly
Secretary



Park Triplett
Treasurer



John Boyer
Curriculum Board Rep.



Paula Nelson
Honor Council



Irene Loe
Honor Council



Lol Leonard
Student Promotions
Committee Rep.



Allison Felton
GPC Representative



Mary Beth Bange
MSAC Representative



Julie Becker
Hearing Committee

PBL Learning



Physician consults with Roy while nurses look on.

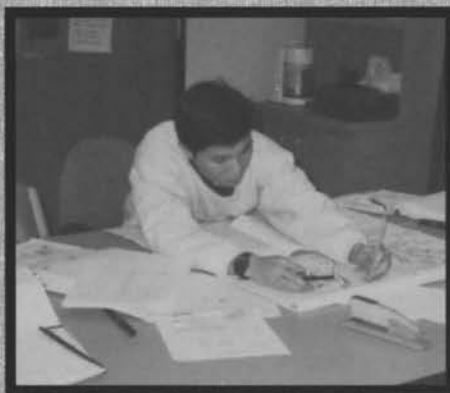

Rusty works on his learning objective.



Sara, reading learning objectives.



Hector transcribes.

Integrating the learning process.



Sandy and Mary Beth discuss the case.



John plays solitaire on the network!



Roy and Sandy break from their busy schedule to pose for a photo.

Casual moments



Theresa and Tiffanie at the M-1/M-2 bowling night.



Colleen with Chris Chase and his wife wait to bowl.

Matt Stelzer feels a little underdressed for the occasion-- "Nobody told me it was formal!"



The "studettes" prepare to scout for guys.
(Ann Saunders, Amy Petterborg, and Sarah McElroy)



Jay, Pete, Sarah and Matt hangin' out.

Class celebrities



Tina and Eric perform the Lambada



Class Celebrities: Whitney Houston and James Dean (Helen and Ric)



Dr. Daugird makes his best impression of Rodney Dangerfield, while students Mary Klix and Sarah McElroy chuckle politely.



Jim Edwards learns the real meaning of the chest exam at A-Review.



I've got my girl and it's time to go surfin', dude. Craig Naugle and date at the formal.

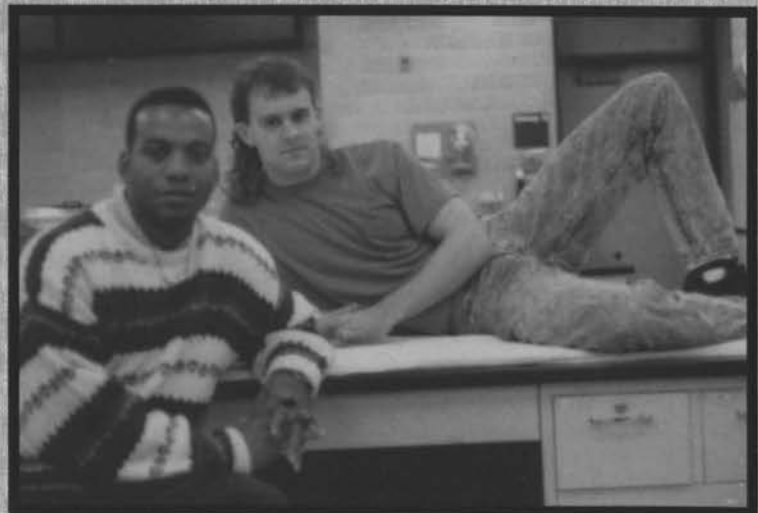

Class Celebrities: Billy Ray Cyrus and Denzel Washington (J. Williams and A. Mitchell) promoting the new fall styles.

Labs



Dr. Nyk explains the situation to bewildered Todd, while Chris confirms the diagnosis. (above)
Nicole keeps talking and talking and talking, Amir Jalali, Irene Loe, listen patiently. (below)

It was all so much simpler in grade school. Brandon Day, Tom Theiss, Steve Haas, and Mike McCullough attempting to distinguish between purple and pink bacilli. (below)



"Yep, I knew that." Mark Sullivan is confident. Dr. Riggs, Rob, and Rusty are doubtful. (below)



Some folks make things happen, some watch things happen, others wonder what the heck happened.

7 AM Gunners hard at work!
(Jim Edwards, Moll, Boyer)

Labs



We've created a monster!!! Kim(stein) Defenbaugh falls prey to Jane Anne Speaker, Chris Litherland and Maerry Lee.



Matt! Wake up--You're dreaming! The images of beautiful Angie Landers, JoAnn Barbour and Lori Dablemont.



Dr. York curiously looks on as he notices that a young student has less hair than himself. Irene Loe and Alisa Ball warn that John Boyer's ears are still out of water.



Chris Chase soothes as Williams pink skin is exposed to the heat lamp in the M-1 tanning salon. Roy looks on.



Oops, cover up the personals!!! Angie Landers practices correct bedside procedure with Matt Taylor.



Class experts experiment with scuba gear. (Shawana Branch, Susan Stackelhouse, Mary Klix, Paula Nelson, & Tina Drury)

Sports

Pro dozes off, Rob daydreams,
Sommer cuddles with Noah,
while Miguel looks down in despair
and James anxiously watches the game.
Foreshadowing:
Chris Bauer clenches his jaw.



THE WINNING TEAM!!!

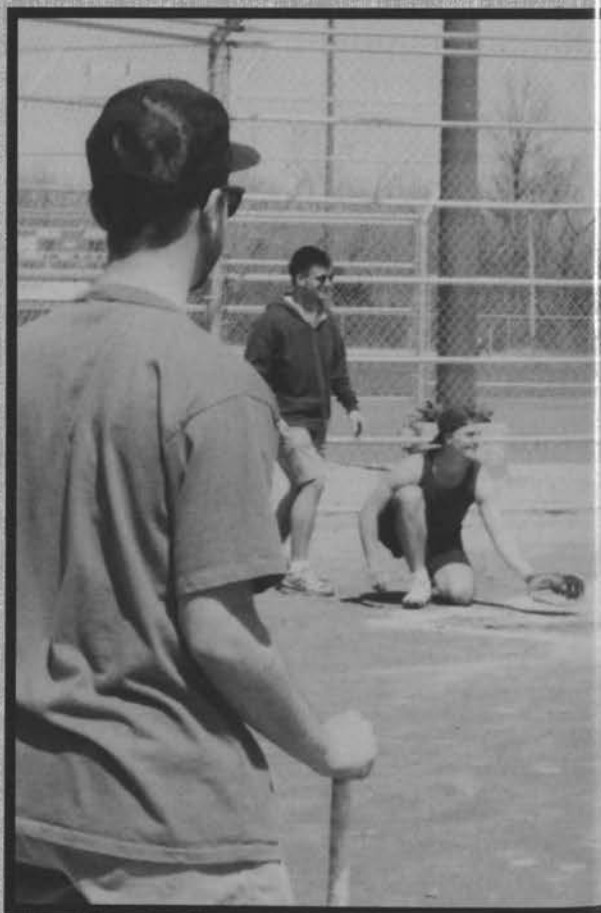

Mary hits a line drive to center field.
(above)



The enthusiastic crowd cheers for the M-1 teams.

Sports



Ann Saunders
sacrifices herself
for a winning game.



Miguel Rivera & Bill Hecht watch
as the ball soars out of the field. (right)



Power hitter, William Moore hits a homerun.



Extracurricular



JoAnn's fiance is head over heels admiring her beauty.



Sister Patricia Mullins fends off rock stars-- Ann (Gina Simmons) Saunders and Theresa (Paula Stanley) Hughes



Allison Felton ropin' the wind with her friendly cow, Sommer Sirawan.

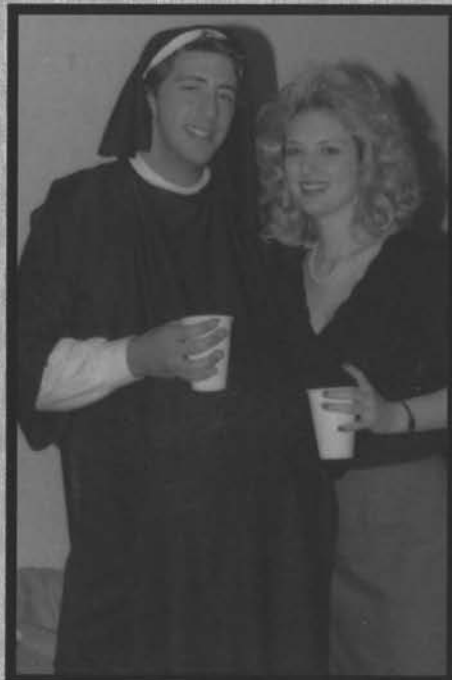

Sister Daria Alexander should have used a condom, but was helpless under the influence of demonness Angie Landers.



Nick is now living in his mansion in Cancun with his genie (Monica Eigelberger).

Activities



Jane Anne Speaker, Roy Phillips, Pat Gilbreth, & Brandon Day show off significant others at formal.



Christy Tharenos, Melissa Altom, Sommer Sirawan, Rob Jensen, Rustico Ramos at the Aesculapian Ball.

Hector Ramos and date.



Black Satin and White Lace were definitely in style this year.



Julie Becker, Rick Coats, and John Boyer with dates.



Nicole Armaly and Chris Litherland with dates. (right)

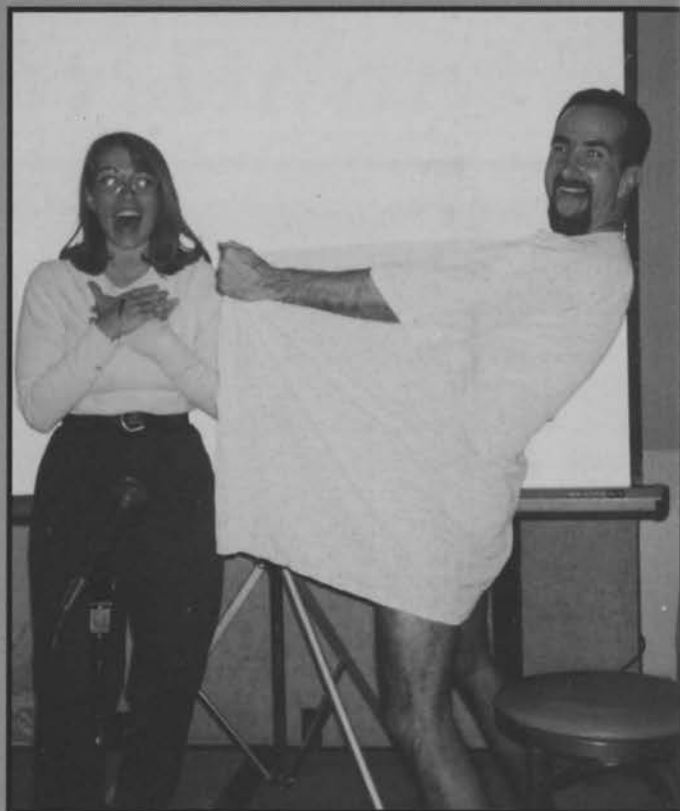

A-Review 1994

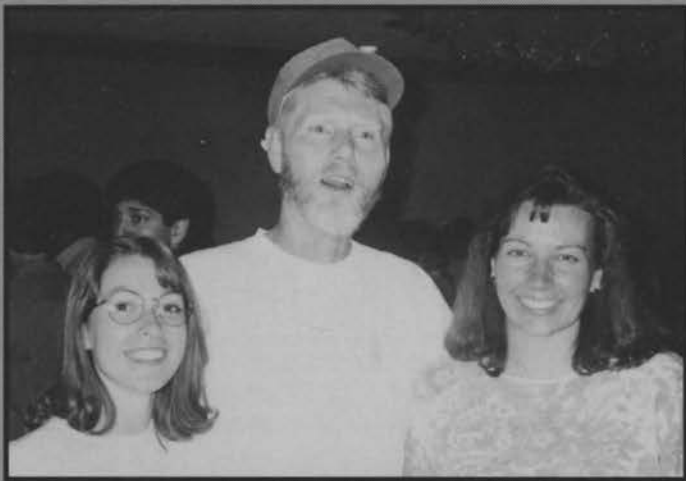



A-Review 1994

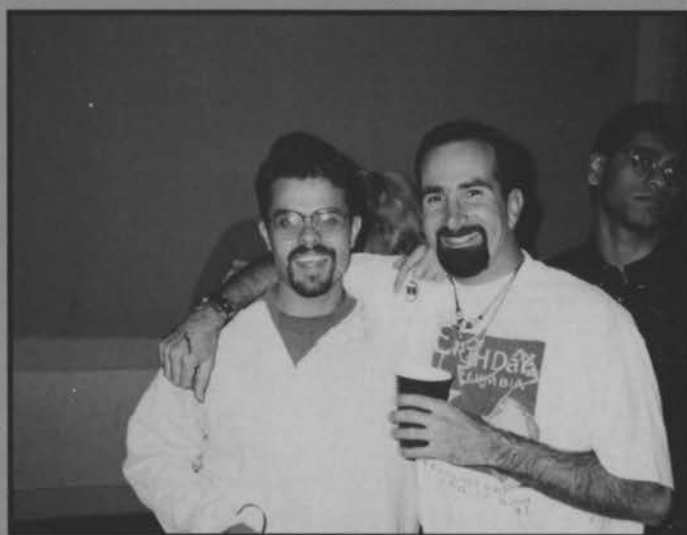



M-2s



Left: "Honest guys, I don't have a drinking problem." (*Sarah Browning*)

Below: *Kristen Kasper* doing her best chipmunk imitation.



Left: M-2 *James Cullison* gets a little help studying from friend *Nikki Kaufmann*.



Right: "Yeah, we took care of him. That's the last time Dr. Hiabauch will ask such impossible questions on our test."



Right: "Come on, let's just get this over with."



Below: "I sure hope he knows what he's doing."
(*Arash Nadershahi, Heather Denison, Manaji Suzuki, Kent Lowry*)



Right: "Isn't my new hair cut cool?" (*Erik Grossmann, Christine Wilmsen, Brad Diestelhorst, Jane Anne Emerson*)



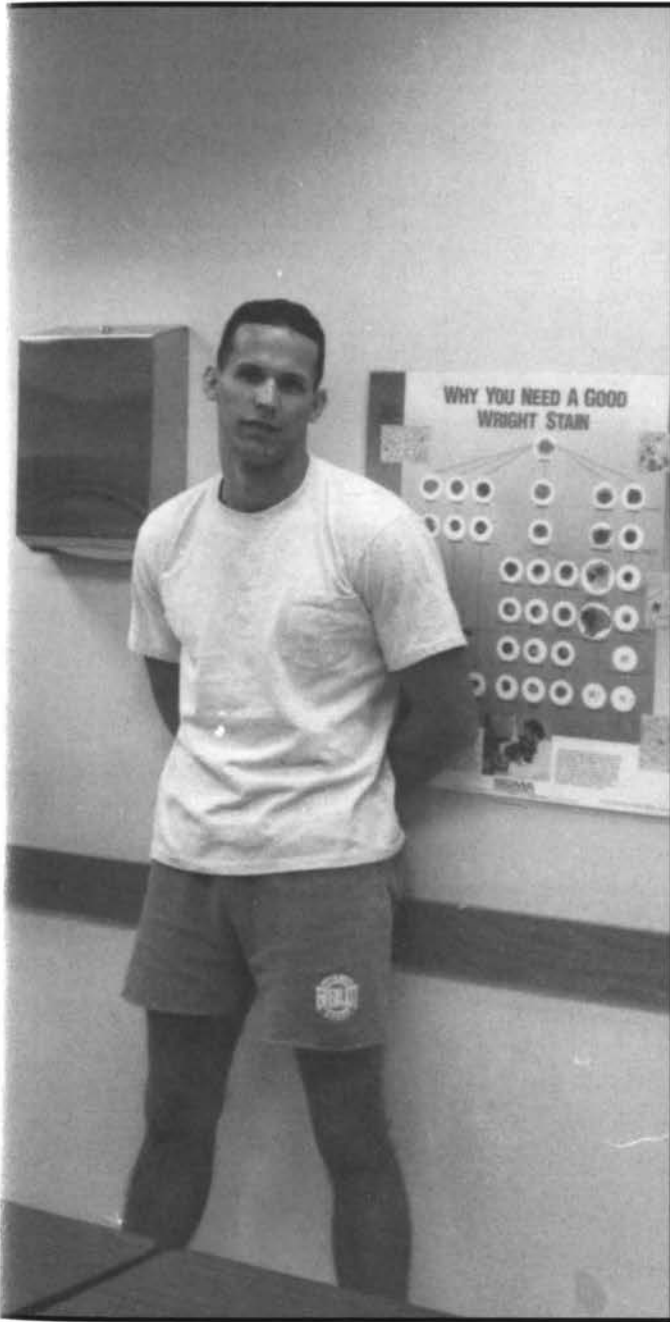

Below: Bart Shaw, M.D. keeps a close eye on these M-2's as they attempt to learn how to draw blood.



Left: Joe Johnson sticks his first victim.



Left: "See mom, I can look pretty even when I draw blood." (*Kristi Glover, Alex Garza*)



Right and below:
M-2 Lab E take time
out for a group
picture.



Right: *Brad Diestelhorst and James Cullison* relax on their day off.





Left: "...And if I die, I want you to have my JD2BMD license plates...."



Above: *Erika Kohanowski* comes in for a landing.



Left: "Hmm . . . Pathology . . . or BEER"

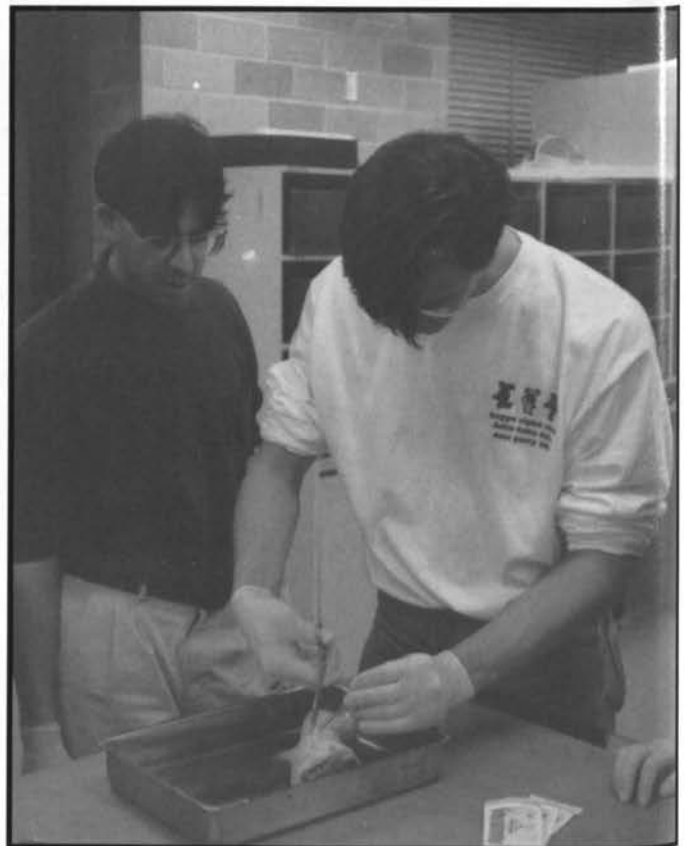
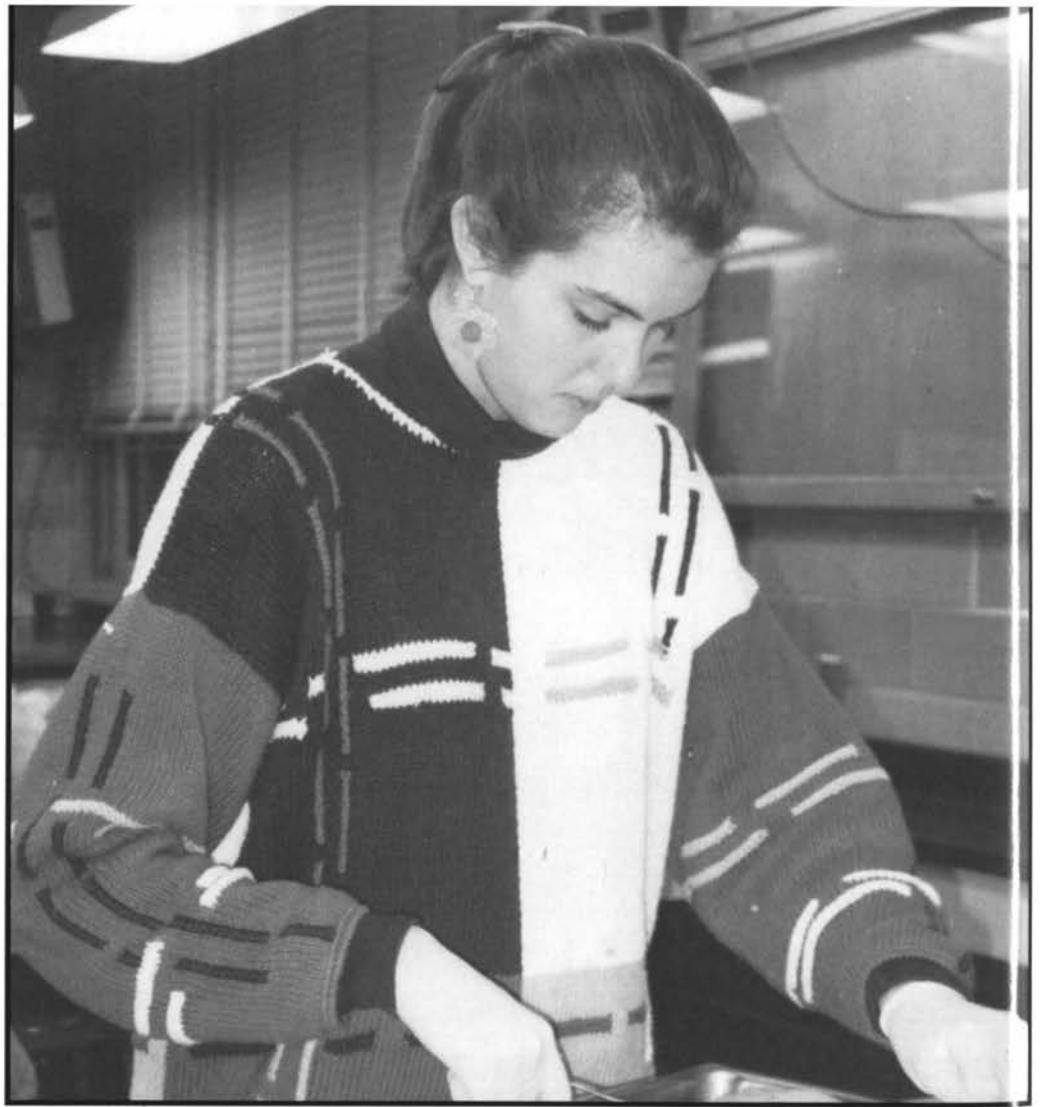

M-2 LAB TIME

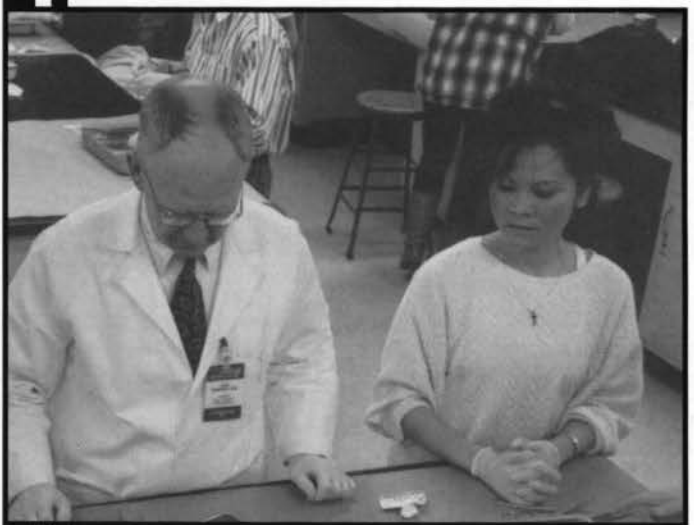

Right: "Smores over a bunsen burner...it just doesn't get any better than this"



Right: *Joe Johnston* modestly reveals his ranking in the class.

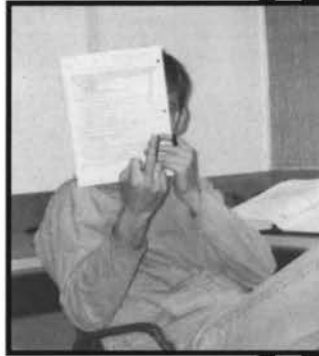

Above: "So what do you think about my new hair cut?"

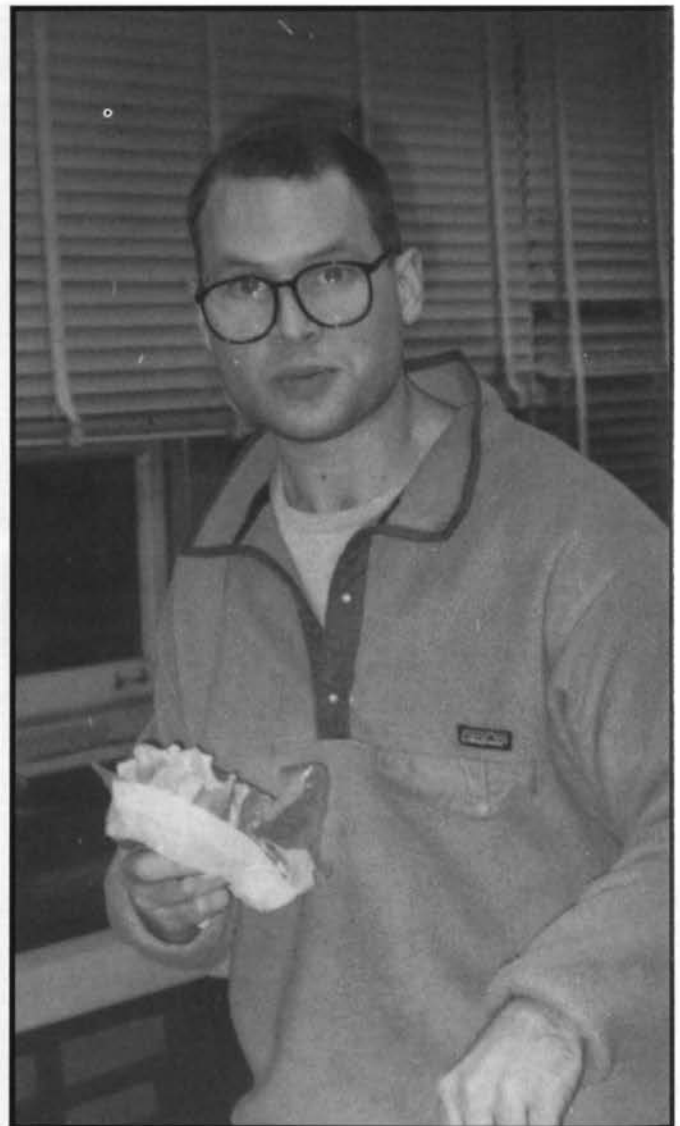

Above: "It's my understanding that there would be no math in this debate..." (*Doug Shaeffer*)



Left: Late night smores. Always remember, safety first.

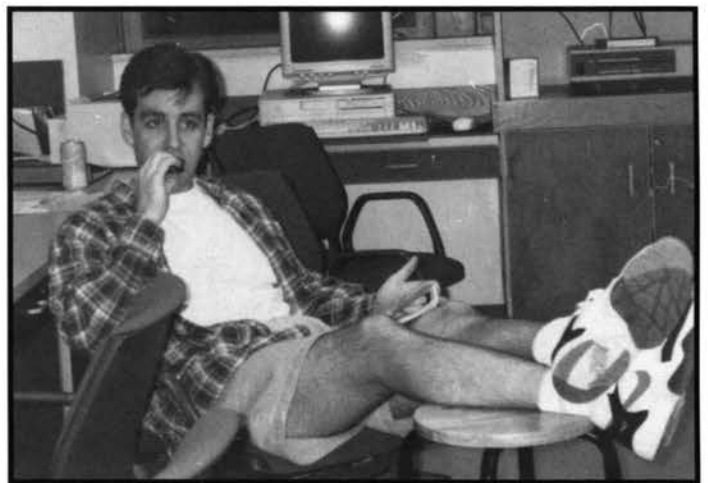

Left: "I just don't think I can take another minute of this!"

M-2 LAB TIME

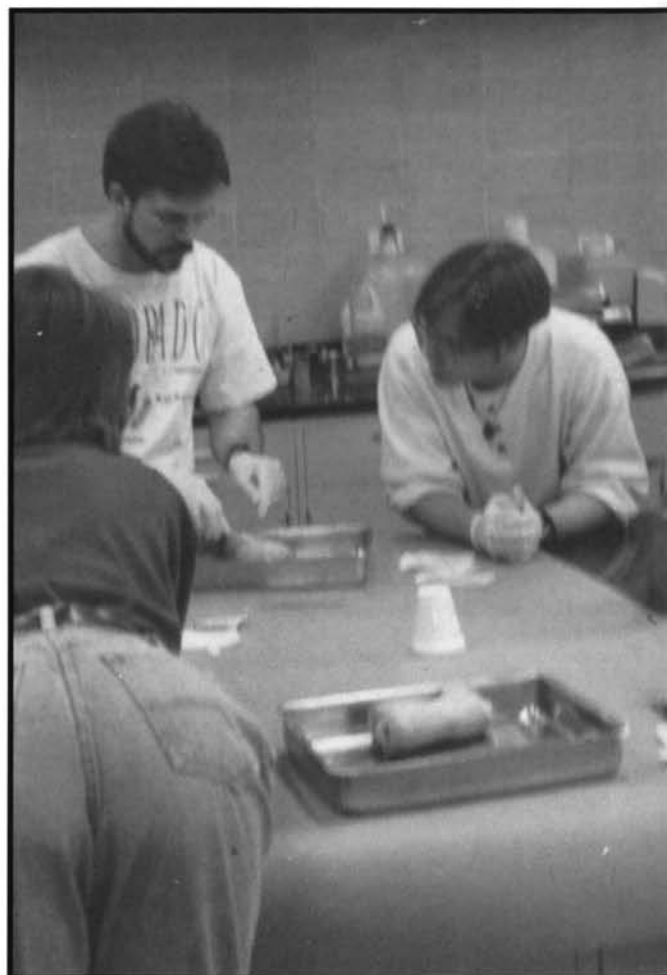

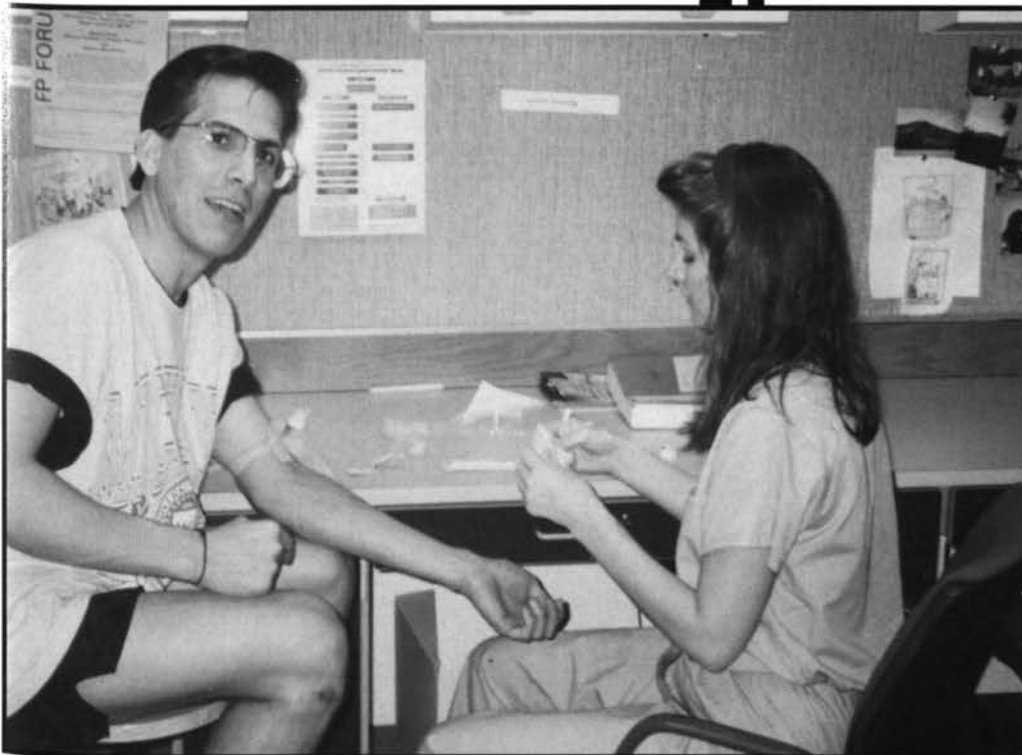
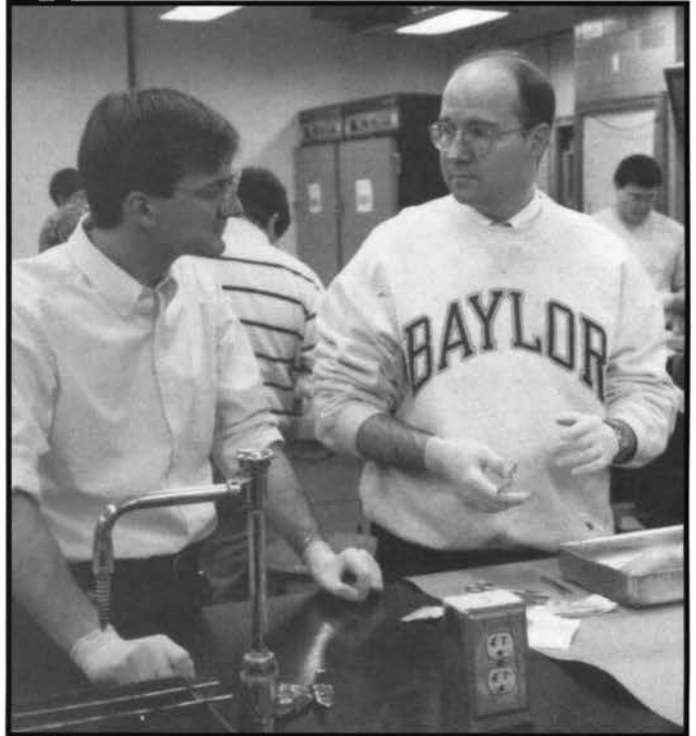

Right: Even Medical students can take time out from studying to enjoy a night out.

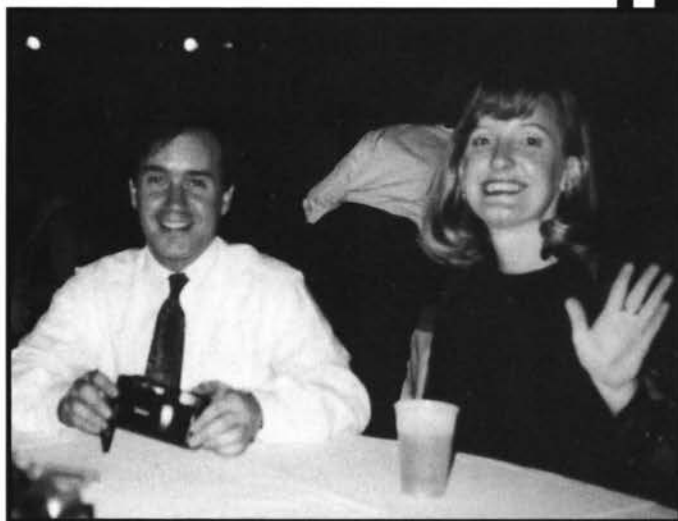

Above: *Heather Dienison* and *Jarin Asher* at formal.

Right: Elvira, Peg Bundy and Mr. Clean go to Medical School.





Left: *Kevin Bell, Joe Johnston and dates at 1994 Medical School Formal.*

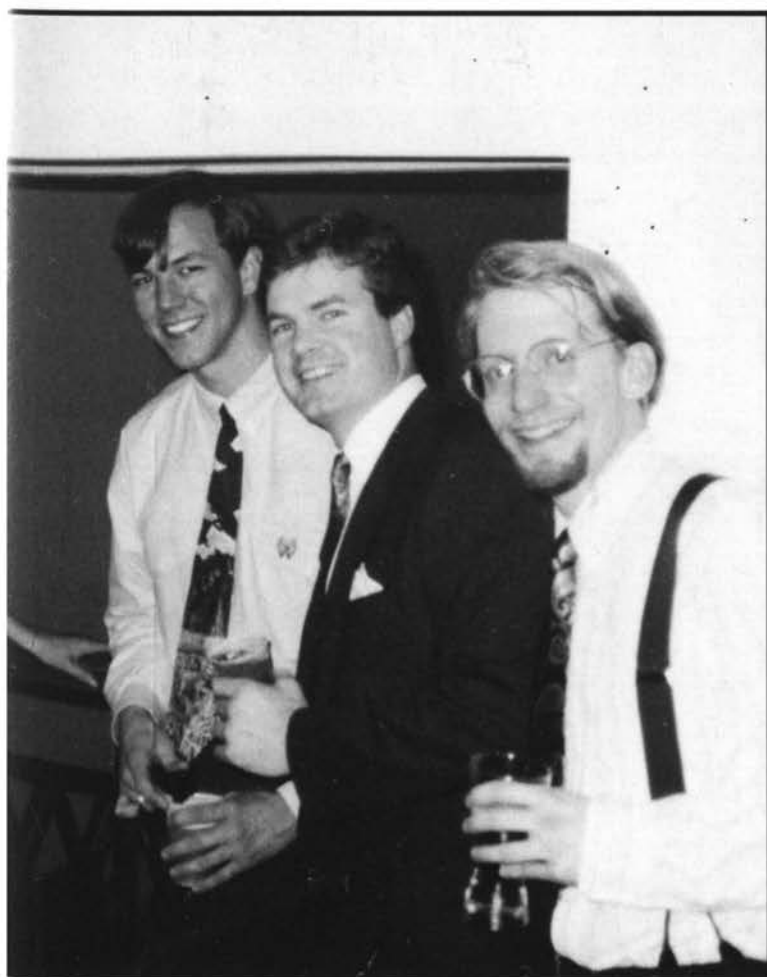

Left: *Jeff Schwab, James Cullison and Lor Hutchinson party it up at formal.*

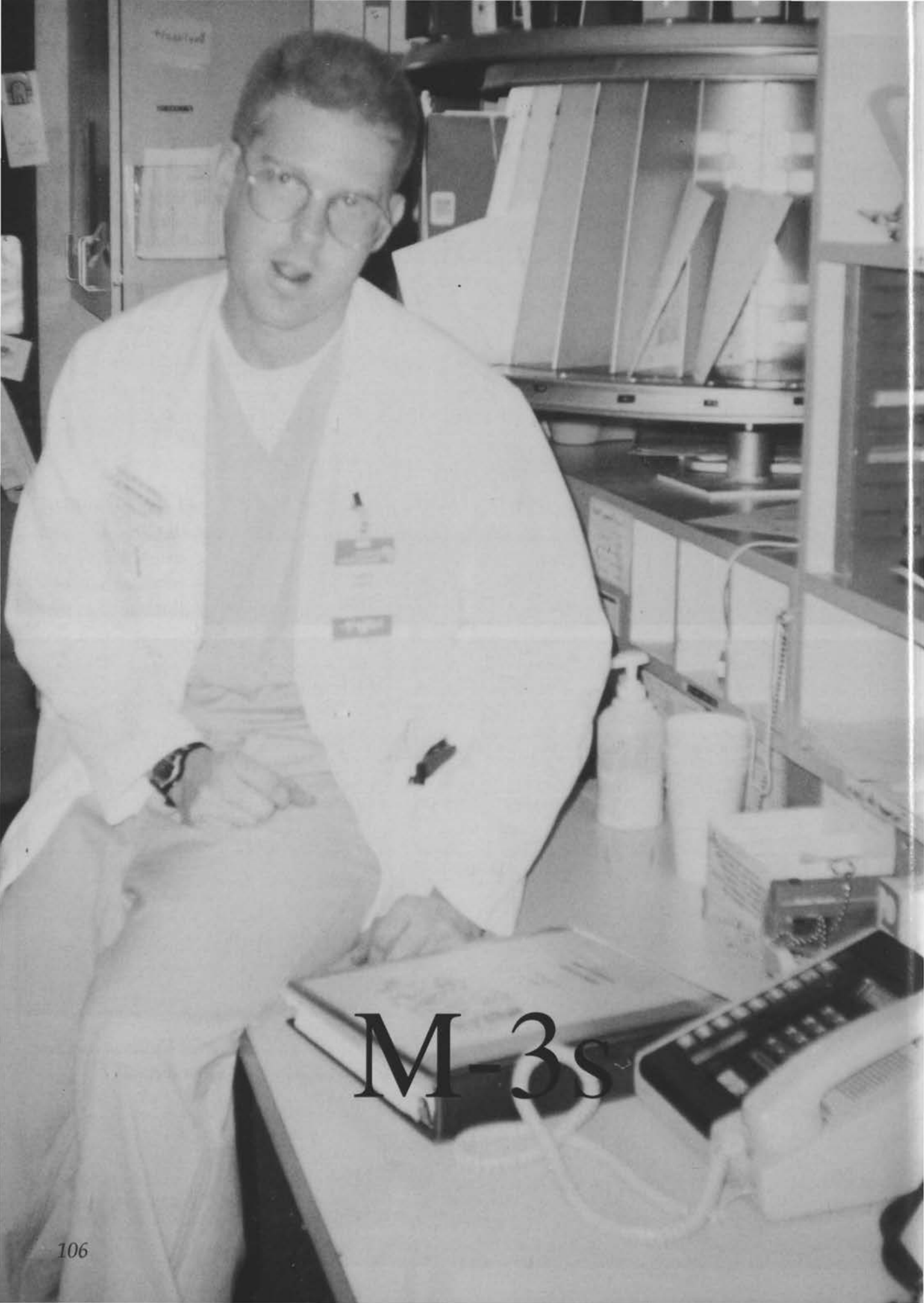

M-3s



Left: "Yeah, I been drinkin'! What do you think you're gonna do about it?" (*Matt Hansen*)

Below: *Laura Tabataba* relaxing at the all school picnic.



Above: *Daxa Patel* becomes an honorary Red-head for the evening. (*Leigh Griggs, Daxa, Denise Zimmer, Kristen Udell*)

Above: *David Mauck* and *Tim Noyes* try to eat as many chicken wings as they can before a very pregnant *Erica* eats them all.

Left: Classmates joined with *Tim* and *Erica Noyes* to celebrate the impending arrival of a Little (Moore) Noyes.



Below: After a rough night on call, *Scott Pusateri* decided to take it easy on Morning Rounds at the VA. Some people are so lazy!



Above: "I detect a slight hint of oregano with just a pinch of garlic." (*Douglas Freeman*)

Above right: *Noel Lumpkin* wonders why she is suddenly so attracted to *Stephen Maxwell*. *Nasser Hanna* can't believe he has to listen to another of *Stephen's* boring stories.

Above: *Trang Du* cheerfully signs in at another boring Medicine lecture. (*John Palmer, Steve Dalbec, Tim Noyes, Trang, Jim Wilkerson*)

Right: Some people will do just about anything to get out of picking up another Antepartum patient. (*Phil Othmer - S/P PE*)

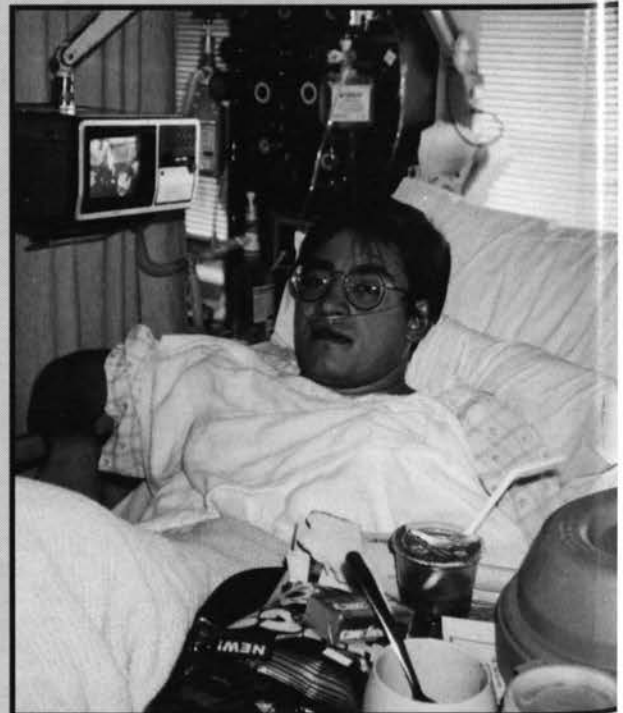

Left: Would you trust any of them as your doctor? (Mohammad Siddiqi, Laura Tabatabai, Drew Shoemaker, Elizabeth Wilson, Tim Staed, Fassel Smith, Jim Wilkerson, Riley Scott)

Right: Riley Scott, Tim Noyes and Jason Mitchell doing the morning Scut Sheet.

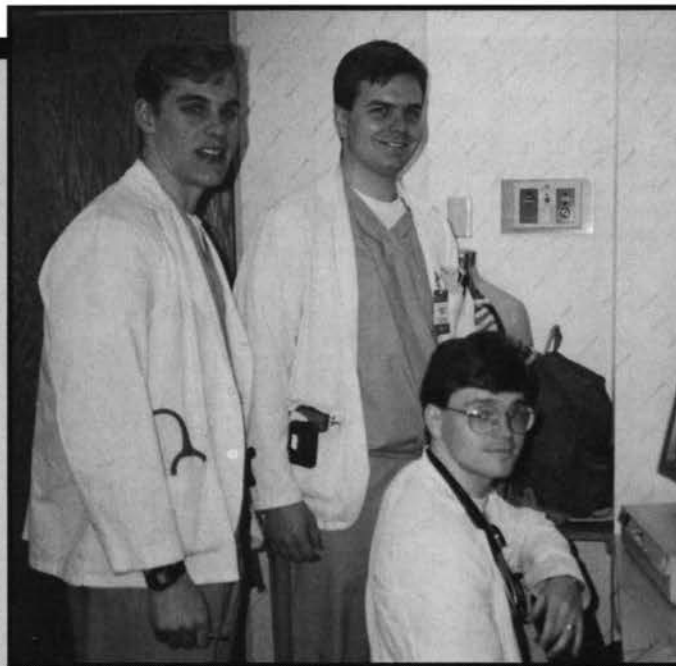

Below: "Please! Help! Get her away from me!" (Dan Coy, Suzanne Dugopolski)



Above: "I just don't get all this Internal Medicine stuff." (Jim Elam)

Right: "Lecture? What lecture? David Crane and Kae Chang do their best Lounge Lizard imitation.



Above: Paul Bunge-brought to his knees by the Department of Child Health.

Right: Dr. Clive Levine... I mean Dennis Luetkemeyer gives Chuck Conway and Jay Padratzik a private session after hours.

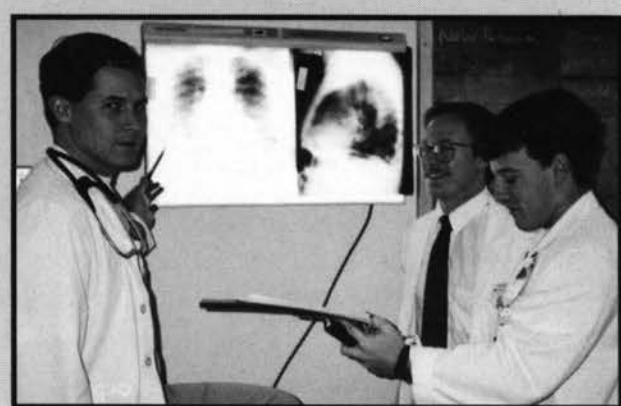

Right: Kristy Smith gets a taste of the good life with a little help from Levonne Lee.

Below: Doug "GQ" Benkelman. Stick with Med School Doug.



Above: "Stay back, he's all mine!" (Glen Georger and Suzanne Dugopolski)

Left: "So Brian (Johnson), how about after this meeting we go cruisin' in my convertible and pick us up some chicks." (Doug Hoff)

Below: "I got my beer, my team is doing well, What more could a man want?!" (Steve LaRue)



Above: Testosterone time-out. (Tom Baudendistel, David Galli, Jay Padratzick, Marc Merbaum, Keith Steinbecker, Dean Smith)





Below: Anna Scott, David Rudman, Glen Georger, Carlos Manookeymschi, Heather Stelling, Brad Trowbridge, Orlando Icaza take time out for a nice home cooked meal.



Above: "O.K. guys, who spiked the Jello jigglers?" (David Mauck, Anna Huger, Steve Keiser and Katie Gaugland)



Right: All this partying sure can make you tired. (Drew Hoemaker with son, Kyle)



Far Right: Mark Chambers enjoying the odds. (LeAnna VanTuyl, Tracy Turner, Mark, Nina Shah, Erika Kohanowski)

Left: Levonne Lee celebrates her birthday in style with a little help from her friends. (Levonne, Janine Klobe, Anna Scott, Matt McGlothlin, Greg Schneider, Philipp Othmer, Boris Volshteyn, Christine Chua)



Below: "Ya know, this Med School thing ain't so bad." (Keith Hill)

Below: Just when you thought it was safe to hide from the camera, your M1 Composite picture comes back to haunt you. (Shari Thompson)



Above: Darla Kliethermes, Suzanne Dugopolski Dr. Groshong and Susan Rapp enjoying the All School Picnic.

Above right: "Oh, please! This is more boring than a Dr. Terry lecture." (Natalie Key, Linda Craska)

Right: Anna Huger and Bob Sharpe manage to squeeze in time to relax at C-Review. "Hey Bob, aren't you supposed to be on OB call!" It would appear some Residents actually remember what it was like to be in Med School.



Left: Roger Ivey and date laughing along with classmates at C Review.

Below: Leigh Griggs shows off the new skills she learned on her Child Health rotation, but it wasn't enough to impress Eise Shoemaker, the local Child expert.



Left: Jay Allen - the Class of 1995's own Mountain Man.

Below: "No, really. I tricked Matt into marrying me. It's amazing how much more financial aid I get this way." (Jane Buss, Anna Hugar)



Left: Heather Stelling, Elaine Wills, Doug Hoff, Meg Browning, Michael Wood, Denise Zimmer, Carol and Robert take a break from studying for Step I of the Boards for a Star Trek murder mystery night.



Left: Family and friends gather to help Sue celebrate her upcoming marriage with a Bridal Shower. (Leslie Tiemann, Christine Chua, Angela Patterson, Betty Quick, Mrs. Fanning, Mrs. Pack, Sue Pack)

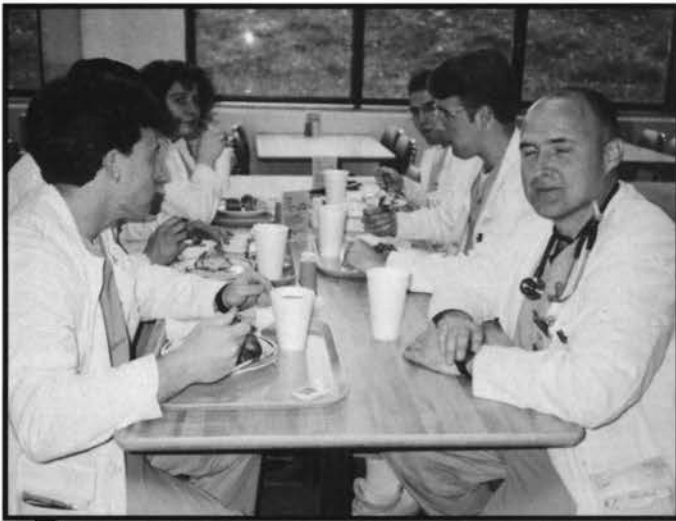

Left: When you are hungry enough, even cafeteria food can taste adequate. (Jay Padratzik, Angela Patterson, Marc Merbaum, Matt McGlothlin, Glen Preston)

Right: John Wright and Thomas Williams anxiously await the start of Pediatric X-Ray rounds with Dr. Levine.



Left: If you want something done right, have a woman do it! Denise Zimmer, LeVonne Lee, Janine Klobe and Darla Kliethermes hard at work planning our Graduation.

Right: No, Leslie. Show us your ring! (Scott Kempton, Christine Chua, Leslie Tiemann)

Below: Douglas Vogt and Scott Griswold paying close attention to a lecture.

Below: "Wouldn't you like to know what I've been doing." (Dan Bell)



Above: Kim Lewis listening attentively to Dr. Terry's talk about Burns.



Left: Gross Anatomy flash back! (Juno So, Russell Smith, David Galli, Samer Garas)



Below: Sue Pack anxiously reviews her notes before presenting a patient to her attending.

Below: Mike McFadden picking up the pieces after getting grilled during a surgery presentation.



Above: Linda Ellis-Laskey enjoys a break from the stress of the Hospital.

Left: Very few people would actually be this happy to be at the VA. (Brad Trowbridge, Joe Sucher, Keith Steinbecker, Nina Shah)

Right: Ah, the care-free days before our rotations began. (Linette Maier, Leigh Griggs, Natalie Key, Angela Patterson, Elizabeth Wilson, Daxa Patel, Linda Craska, Phil Othmer, Kae Chang, Thomas Williams)



Below: John Sears finally found someone to sit still for all of his picture taking.



Left: Janine Klobe, Laura Sievert and husband at their audition for a Mountain Dew commercial.

Below: Three red heads together. Trouble looking for a place to happen. (Angela Patterson, Denise Zimmer, Leigh Griggs)

Below right: Jay Padratzik working on that chronic halitosis.



Above: Toby Freebourn dreams of winning the Boston Marathon while camping out after the Gin Blossoms concert.





Left: *Chanda McDaniel* and *Dan Casey* attempting to soak up some culture at the Art Institute of Chicago.

Below: A Kosher fruit salad. (*Jeff Siegel, Anna Scott, Jay Padratzik*)



Left: *Jay Padratzik, Anna Scott, Laura Tabatabai* and *Samer Garas* living it up at a Cardinals game.



Below: "Ahoy maties, stay away from my beer." (*Dennis Luetkemeyer*)

Below: *Lynn Ogawa* enjoying the great outdoors at the Pinnacles Park.



Right: "What makes you think we don't truly enjoy these early morning surgery conferences?" (Angela Patterson, Carla Foster, Dennis Luetkemeyer, David Kropf, Hunter Hoffman, John France)



Right: Some people just seem to enjoy the OB/GYN lectures a little more than others. (Mark Smith, Lewis Ha, Lynne Ogawa)



Far Right: Susan Rapp, Scut Queen of Blue Surgery.



Above: Kristy Smith, Nina Shah and Lisa Garza hard at work in the 7E swamp during their Child Health rotation.

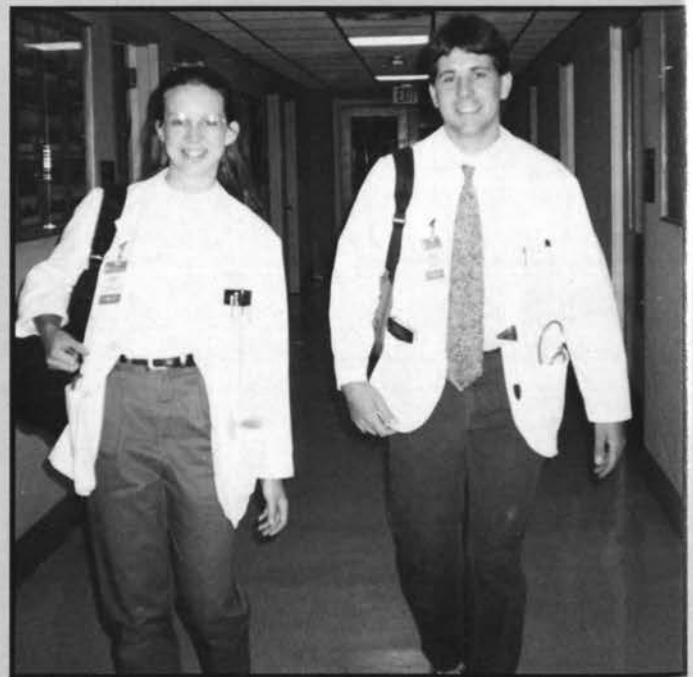

Above: Young doctors on the move. (LeAnna VanTuyl, Mike DiBernardo)

Right: Another day, another Progress Note at the VA. (Eric Nottmeier)



Left: *Todd Rockett* and wife *Jill* welcome the newest member of their family, *Joshua*, into the world.

Below left: *Steve Pepper* stops studying long enough to pose for the camera.

Below: Ah, the wonderful early days of surgery!
 (Row 1 - *Matt Buss, Bernie Esser, Laura Tabatabai, Russell Smith*. Row 2 - *Steve Dalbec, Steven Douglas, Blaine Easley, Jim Wilkerson, Elizabeth Wilson*. Row 3 - *Greg Curry, Blake Alexander, Stephen Hunsley*. Row 4 - *John Palmer*. Standing - *Drew Shoemaker, Mohammad Siddiqi*.)

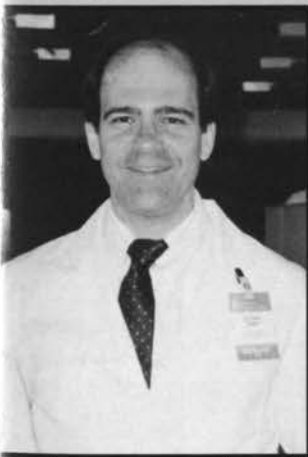

Above: *Rick Burch* manages to sneak a few minutes of quality time with wife, *Kathryn*.

Above: *Lisa Thompson-Lanza* - so many babies to deliver, so little time.

C-Review



Jenny LaBarge serves as the cheerful hostess of the 1994 C-Review.



Jane "Dr. Sotiropoulos" Caldwell demonstrates the anti-Weber residency interview method.



ACTORS: The M4 stars of C-Review learn their lines well in advance of the skit: "M4 Year In Review."



PBL: A few M1s (Amir and Mary Beth) learn the keys to clinical medicine from Shaban Nazarian.



Sharif takes a break from his last rotation.



The Lounge Lizard (Sara Holland) and a generic M4 (Deanna Siemer) discuss the size of rings.



1994



Tim Miller belts out his best imitation of David Bowie.



Jeff Siegel, an M4 to be, percusses the diaphragmatic excursion.



Carlando (Orlando and Carlos) and David enjoy the show, the beer, and the bright cups.



Lacking a better name, the M4 Crooners play with their eyes closed (and an M3 on drums).



Nancy Witt, Holly Bondurant, and Lara Wakefield discuss forming a new basketball team.



Kristen "Jill Henley" Udell precisely completes her residency application.



Tama, her fiancé Mike, and friend Rhonda are amazed by the size of Tama's... Ring.

C-Review



Greg Schnieder and Denise Zimmer play \$20 Pyramid: "Dr. Larson, it looks like you have grown some more hair..."



Mark "Charlie Bondurant" Wakefield attempts to quietly awaken an NSICU patient with a soft sternal rub.



Cairene Williams learns that...



John Mruzik makes a call to his favorite M3.



Tim and Raj perform a tribute to their mentor... Bob Marley.



During a residency interview, Joel "the Chairman" McKinsey berates an M4 for not deciding whether he is a circle or an oval.



Jason Mitchell entertains the ladies.



Joel McKinsey asks Ger² to spell:



Jasmine and Shaban are dating.



With appropriate glamour and glitz, the Lounge Lizard for the 1994 is caped and crowned. (Sara Holland actually made that cape.)



Rich Knight: the 1994 Lounge Lizard.



Mitch Rosenholtz wonders why Sharla won't put her tongue in his ear.



While being thoroughly entertained, Ron and Lance are surprised to learn that students are not treated well on surgery.



"dysdiadochocinesia."



Cairene refrains from dumping her beer on Tim Miller, as he wonders if she has Tourette's syndrome.



Elizabeth Wilson, M3, is delighted to get another call from her secret admirer.



M-4s

*MU*tation 1994



Waiting for the Truck & Tractor Pull to begin...



Step right up, do you have a photo ID?



Ronnie & Nolan sharpen their lucky No. 2's.



Thanks to our curators...luxurious accommodations. Not pictured: Chancellor, Charles Keisler.



Jill laments, "Did I put 'A' or 'C'?"



Four Guys destined to fail the USMLE II...John, Mark, Lindall, Joel.

All-School Bar-B-Que



Two cooks are better than one, says Steph and Heidi.



Master Chef & Genital Surgeon, a dangerous combination. Hot dogs anyone?



Patty Hoffman-Calvo hangs with the underclassmen.



Dr. Groshong poses with Sandy & Suzanne



Even student leaders need to eat.

BELOW: Ronnie & Dana watch as a small child attacks Nolan Snider.



LEFT: Sara, Nan, and Nolan smile uncontrollably while looking at the bar-b-que.



Sharla sure knows her brats.

What a bunch of hooligans; and away to Herman we go.

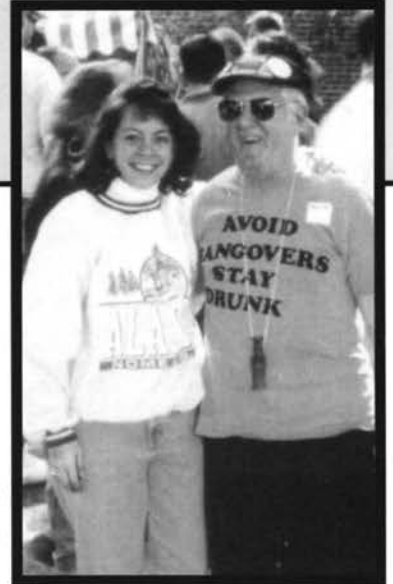

RIGHT: Jenny gets some good advice.

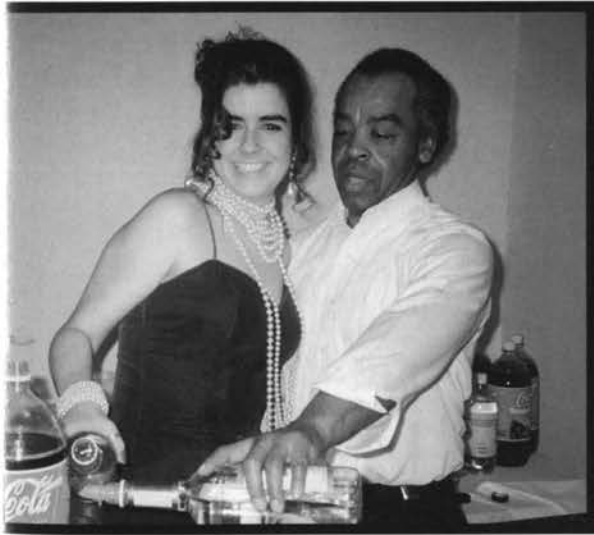

Danielle works an extra job to make up where student loans left off.



Danielle close up...Did I see you on 'America's Most Wanted'?



Homecoming King & Queen, Steve and Barbie Whitt.



Senior chaperones at the Prom.

STUDENT GRAND ROUNDS

IN THE FALL OF 1993 MSAI INITIATED A SERIES OF LECTURES, GIVEN BY STUDENTS FOR STUDENTS. THIS WAS THE CREATION OF STUDENT GRAND ROUNDS. WITH THE SUPPORT OF THE OFFICE OF MEDICAL EDUCATION AND FAMS, THE ROUNDS WERE A GREAT SUCCESS. HALF A DOZEN TALKS WERE GIVEN, WITH SUBJECTS RANGING FROM DIABETES TO AIDS, AND FROM HANTAVIRUSES TO HEALTH CARE REFORM.

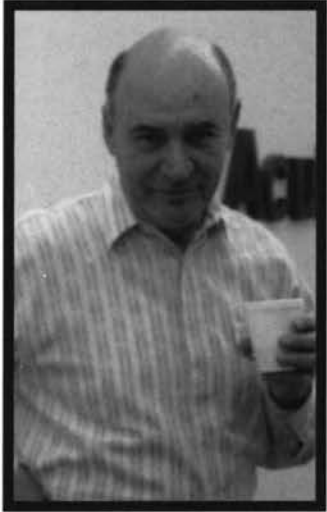

COFFEE & COOKIE GURU, DR. ORR.

RIGHT: STEVE T. WAS HAPPY TO POSE NEXT TO HIS HIV/AIDS BANNER.



LEFT: AMA MEMBERS, HUGH STEPHENSON, MD AND M-2 SAM HUGHES DISCUSSED HEALTH CARE REFORM.



LAURA BEN JUDEN GAVE A PERSONAL LECTURE ON INSULIN-DEPENDENT DIABETES MELITUS.

DR. WAKEFIELD DISCUSSED THE ELUSIVE HANTA VIRUS TO THOSE INTERESTED IN ID.



MSAC CHAIR, JANINE PINGEL, DISCUSSED THE RECENT LCME VISIT. SHE ENTERTAINED A LIVELY DISCUSSION ON THE MERITS OF HAVING A TV IN THE MEDICAL STUDENT LOUNGE.



The student lounge is IDEAL for Thanksgiving.



Two clowns goofing off at Halloween.



After watching the turkey get carved, we understand why Joel chose Medicine over ENT.

M4 Candida



Jill & Sally have a ball together at Mizzou Lanes.

BELOW:
The omnipresent class president and softball pitcher.

BELOW:
Candice Cope is happy to get out of the minors and play in the big leagues.

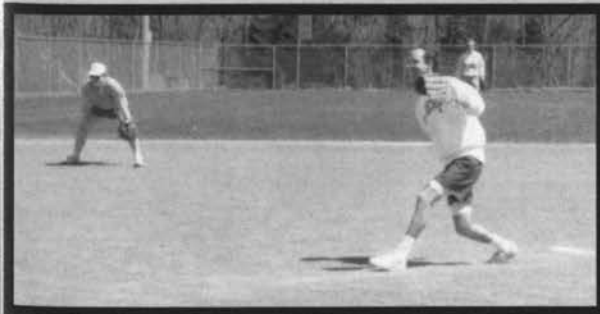

Coaches Whitt and Scoles discuss strategy.



M-4s At Work.....

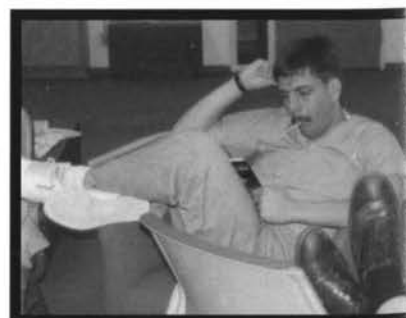

.....And At Play !!



M4 Travel Guide

"The wise man travels to discover himself."

-James Russel



Shaban pokes around Mesa Verde, near Cortez, Colorado.



Laura Den Ouden climbed to the top of the North Pole looking for Christmas gifts.

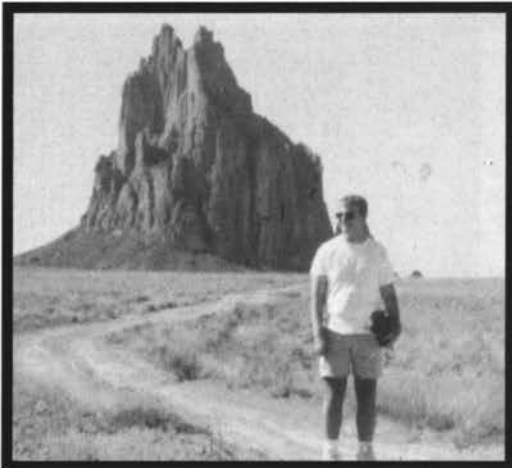

Moonpie Mark is searching for snacks in Shiprock, New Mexico.

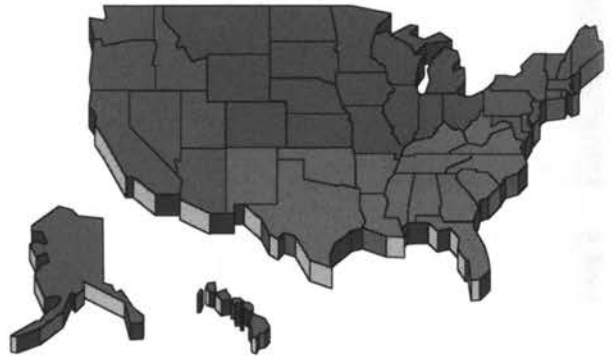

Janine Pingel climbs out of the Grand Canyon.

Elvis lives... in South Dakota!



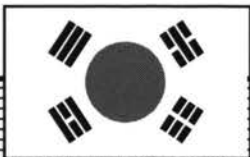
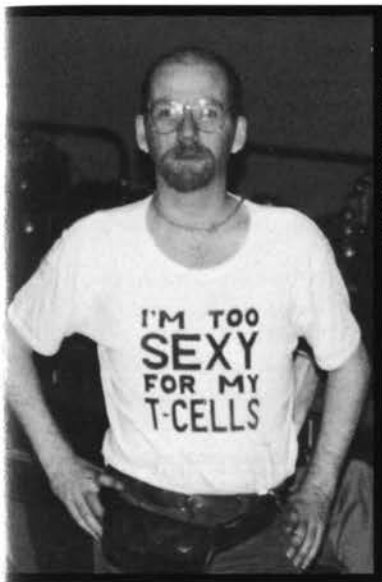

Heidi Chua hangin' out in Seoul, Korea.

Steve Tucker made lots of friends at the AIDS Conference in Berlin.



Dr. and Mrs. Imlay vacationing in the South of France..... no, no, no, that's Minnesota.



Joel points out his preference for Pscophath Gulley over Frosty's Freeway in Colorado.



We don't know where Ger, Rob, Raj, Tom, and Mike went...and they don't remember!



The Rentz family...Back from the Future. Where is Caryl?



Susan enjoys the view in Colorado.

M4 MADNESS



Sara and Cathy aged only slightly during the last 4 years.



America's Most Wanted



"Quick, slam your bat-juice and I will take you to the bat-cave ...heh heh heh."



The Mruzik Family sits for a Norman Rockwell painting.



Do you think Laura gets the message?



"I never realized how cute Rob is. I am oddly attracted to him."



"I never realized how cute Raj is. I am oddly attracted to him."

"Rob & Raj never think about me. I must not be that cute."





No caption necessary.



An evening out with the Columbia Ladies Auxillary Club.



Mom's night out.



Lindall hopes he matches.

No Steve.
Don't burn
your camera
in the fire.
I'll take the
pictures.



Amazing how Sue P. balances
a tree on her head.



M4 MADNESS





Robert Alley, MD

Leeton, MO

B.S.

Central Missouri State U.

Psychiatry

University of Missouri

Columbia, MO

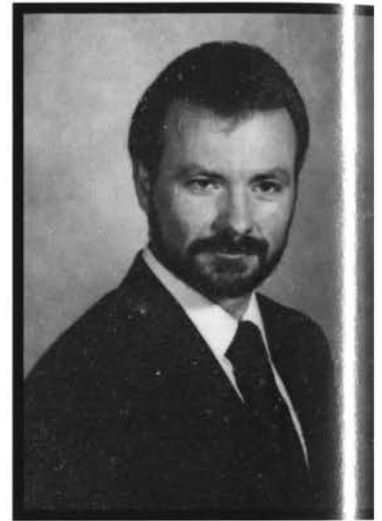

Chris Andershock, MD

St. Louis, MO

B.A. Biology

University of Missouri

Emergency Medicine

University of Michigan

Ann Arbor, MI



Tom Baker, MD

Holliston, MA

B.A.

Earlham College

Internal Medicine

University of Missouri

Columbia, MO





Bill Bentz, MD
 Neosho, MO
 B.S. Biology
 Missouri Southern State College
 Internal Medicine
 E. Tennessee State University
 Johnson City, TN



Lauren Blackwelder, MD
 Sikeston, MO
 B.S. Interdisciplinary Studies
 Emphasis in Biology, Chemistry,
 and Psychology
 Southeast Missouri State University
 Medicine/Pediatrics
 University of Tennessee College
 of Medicine
 Memphis, Tennessee



Daniel Blaschak, MD
 St. Louis, MO
 B.S. Chemistry
 University of Missouri
 Transitional Year
 Anesthesiology
 Mayo Clinic
 Jacksonville, FL



*If you're not the lead dog,
 the view never changes*

*The life so short,
 the craft so long to learn
 -Hippocrates*

Sally Anne Bomar, MD
 Mound City, MO
 B.S. Biology
 Missouri Western State College
 Family Practice
 Truman-East Medical Center
 Kansas City, MO

*It was the best of times;
 it was the worst of times
 -Charles Dickens*



Thomas A. Brant, MD
 Jefferson City, MO
 B.A.
 Westminster College
 Emergency Medicine
 Metro-Health Medical Center
 Cleveland, OH

*Cold brew
 is good for you.*

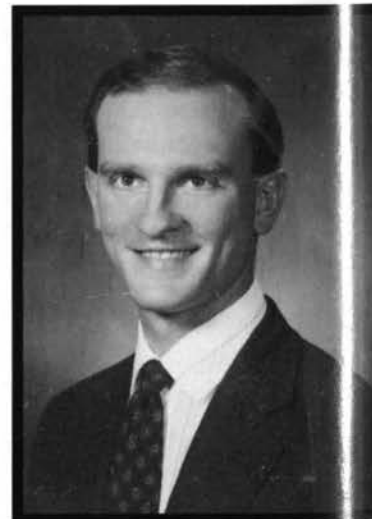

Sharla Marie Brown, MD
 Independence, MO
 B.A. Biology
 University of Missouri
 Obstetrics and Gynecology
 University of Kansas
 Kansas City, KS





Jane Caldwell, MD
 Fairview Heights, IL
 B.A. Biology and History
 Washington University
 Transitional Year
 St. John's Mercy Medical Center
 St. Louis, MO
 Anesthesiology
 University of Missouri
 Columbia, MO



*It was the best of times;
 It was the worst of times
 Charles Dickens
 A Tale of Two Cities*



Patricia Calvo, MD
 Clayton, MO
 B.A. Biology
 St. Mary's University
 San Antonio, TX
 Obstetrics and Gynecology
 Saint Louis University
 St. Louis, MO



Stephanie Carron, MD
 St. Louis, MO
 B.S. Biology
 University of Missouri
 Pediatrics
 University of Alabama
 Birmingham, AL



*When every other element
 is out of control,
 remember you can still
 manage your reaction.
 Robert Schuller*

Joe Castrejon, MD

La Mesa, CA

B.A.

U. of California-San Diego

Family Practice

U of Southern California

Whittier, CA



Heidi Ko Chua, MD

St. Louis, MO

B.A. Biology

Washington University

General Surgery

Mayo Clinic

Rochester, MN



*Practice Randon Kind-
ness and Senseless Acts
of Beauty*

Tom Ciolino, MD

St. Louis, MO

B.S. Biology

St. Louis University

Internal Medicine

St. Vincent Hospital

Indianapolis, IN



*Medicine...the only
profession that labours
incessantly to destroy
the reason for its own
existence*



Peter Cleavinger, MD, PhD

Moberly, MO
B.A. Biological Sciences
PhD
University of Missouri
Internal Medicine
Mayo School of Medicine
Rochester, MN



*Yeeooooow,
I Feel Good!
-James Brown*



Candise Cope, MD

Rogersville, MO
B.S. Biology
University of Missouri
Family Practice
Cox Medical Centers
Springfield, MO



*You must get involved to
have an impact. No one
is impressed with the
won-lost record of the
referee
--John H. Holcomb*



Karrie Cunningham, MD

New Melle, MO
B.S. Chemistry
Southwest MO State University
Obstetrics and Gynecology
University of Texas-Houston
Hermann Hospital
Houston, TX



*Life can only be under-
stood backwards, but it
must be lived forwards.
Adversity is never
pleasant, but sometimes
it's possible to learn
lessons from it that can
be learned in no other
way.*

Sharon Lynn Curtis, MD

Indianapolis, IN
B.S. Psychology
Lincoln University
Psychiatry
Duke University
Durham, NC

...And what is as important as knowledge asked the mind... caring and feeling, replied the soul

Talent is not a commodity, discipline is. It takes commitment more than genius to realize your dreams.



R. Brian Deem, MD

Carl Junction, MO
B.S. Biology
Missouri Southern State College
Family Practice
Cox Medical Centers
Springfield, MO

People don't care how much you know until they know how much you care.

*Let your light so shine before men, that they may see your good works, and glorify your Father which is in heaven.
Matthew 5:16*

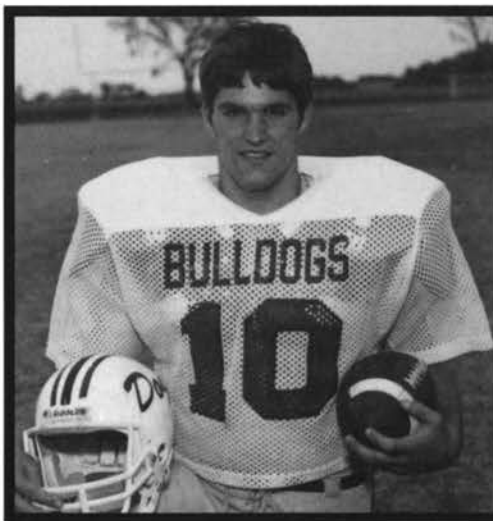

Laura B. Den Ouden, MD

Springfield, MO
B.A. Biology and Chemistry
Drury College
Internal Medicine
Medical College of Wisconsin
Milwaukee, WI

*Lose your dreams and you will lose your mind
--The Rolling Stones*





Dana Eissler, MD

Columbia, MO

B.S.

University of Missouri

Internal Medicine-preliminary

Physical Medicine &

Rehabilitation

University of Missouri

Columbia, MO

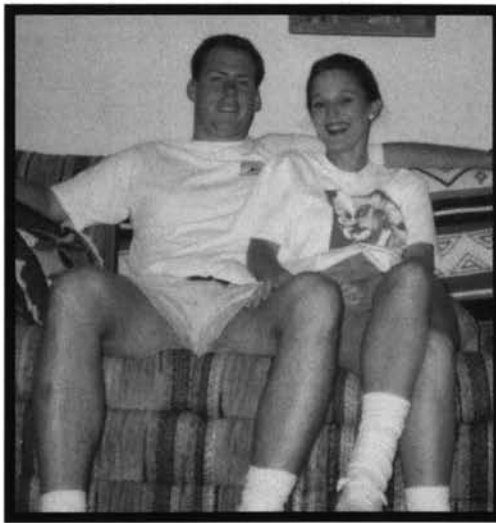

Karen Franklin, MD

St. Marys, MO

B.S. Biology

St. Louis University

Internal Medicine

University of Missouri

Columbia, MO



Judge your success by the degree that you're enjoying peace, health, and love.
--H. Jackson Brown, Jr.



Tama Lynn Franklin, MD

Buffalo, MO

A.B. Chemistry

University of Missouri

Obstetrics and Gynecology

Creighton University

Omaha, NE



Follow your dream wherever it leads--Don't be distracted by less worthy needs... Shelter it, nourish it, help it to grow--Let your heart hold it down deep where dreams go. Follow your dream, pursue it with haste; life is too precious, too fleeting to waste.. Be faithful, be loyal, then all your life through the dream that you follow will keep coming true.
--author unknown

Joseph Frank Galate, MD

Kansas City, MO
B.S. Biology
Rockhurst College
General Surgery
Cleveland Clinic Foundation
Cleveland, OH

The end justifies the means.
--Machiavelli

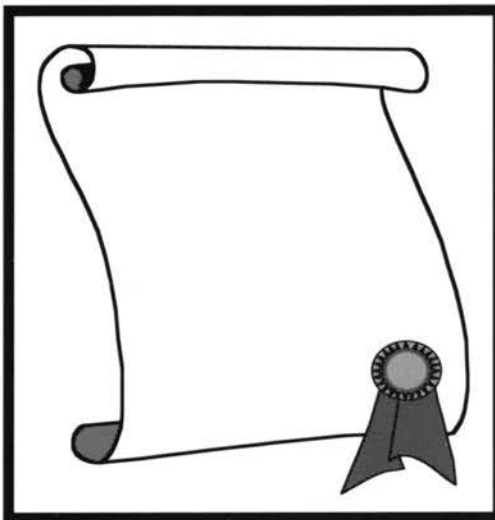

Alex Garcia, MD

Pico Rivera, CA
B.S.
U. of California-Irvine
Psychiatry
University of California
San Diego, CA



Gerry R. Gerry, MD

Hickman Mills, MO
B.S. Biology
Central Missouri State U.
Pediatrics
Children's Mercy Hospital
Kansas City, MO

Laugh loudly.
--And Often.

Ger

Never forget those who once lowered the rope.
Ger





Jill Henley, MD

St. Louis, MO
B.S. Biology
Southern Methodist University
Pediatrics
Loyola University
Evanston, IL



...to leave the world a little bit better, to know even one life has breathed easier because you have lived. This is to have succeeded.

--Emerson

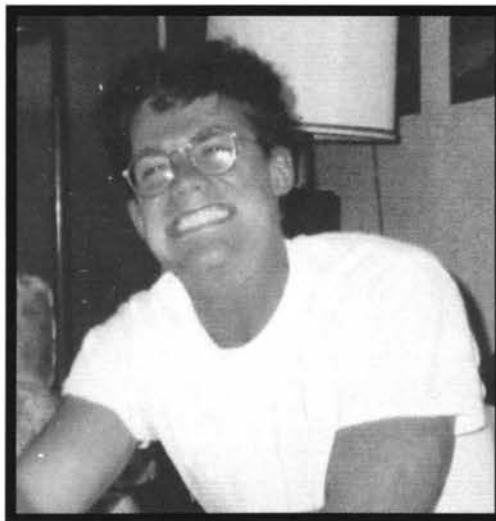
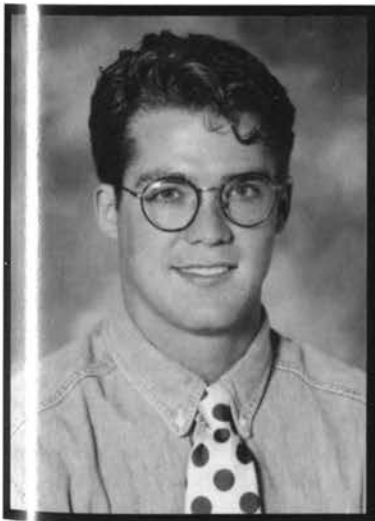

Rob Hibbard, MD

St. Louis, MO
B.A. History
Dartmouth College
Emergency Medicine
University of Illinois
Chicago, IL



All of us have our own niche in society. It is only a matter of finding it.

R. Hibbard



Christina Hicks, MD

Fulton, MO
B.A. Biology
Westminster College
Pediatrics
University of Missouri
Columbia, MO



Do the best job you can do--One day at a time.

--C.H.

Jamie Hileman, MD

Kirkwood, MO
B.S. Exercise Physiology
M.S. Exercise Physiology
U. of Wisconsin-Madison
Diagnostic Radiology
Methodist Hospital
Indianapolis, IN

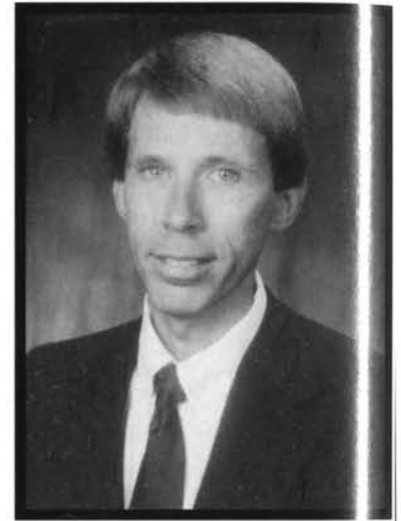

Sara Holland, MD

Columbia, MO
B.A. Biological Sciences
University of Missouri
Obstetrics and Gynecology
U. of Texas Medical Branch
Galveston, TX

*There's nothing wrong
with education,
so long as it doesn't
interfere with your
thinking.*

*Ben Cartwright
Bonanza*



Barb Howard, MD

Westphalia, MO
B.S.
Northeast Missouri State U.
Plastic Surgery
Ohio State University Hospitals
Columbus, OH





Susan Teresa Hunze, MD
 Cape Girardeau, MO
 B.S. Biology & Psychology
 University of Tennessee at
 Martin
 Obstetrics & Gynecology
 St. Vincent Hospital
 Indianapolis, Indiana

*If I can stop one heart
 from breaking,
 I shall not live in vain
 If I can ease one life the
 aching,
 Or cool one pain,
 Or help one fainting robin
 Unto his nest again,
 I shall not live in vain.*
 --Emily Dickinson

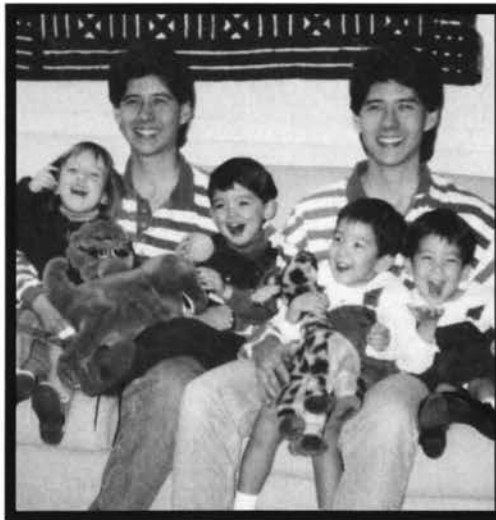
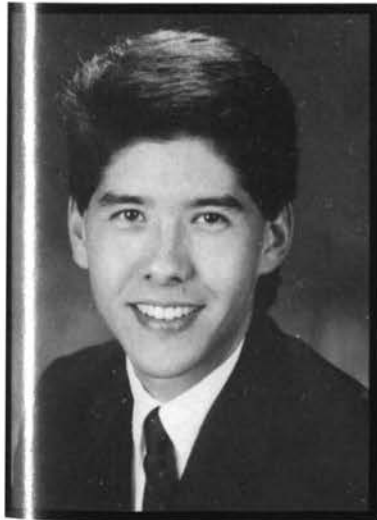

Sherwin Paq Toi Imlay, MD
 Columbia, MO
 B.S. Biochemistry
 University of Missouri
 Pathology
 University of Iowa
 Iowa City, IA

*Don't worry,
 Be happy!*
 --Bobby McFerrin



Rebecca Buskill Kelley, MD
 Richlands, Virginia
 B.S. Biology
 Radford University
 B.S. Medical Technology
 University of Missouri
 Family Practice
 University of Missouri
 Columbia, MO

*Dedication of the spirit
 can overcome the confines
 of circumstance.*
 --M. Ghandi



W. Shannon Kelly, MD
 Springfield, MO
 B.S. Animal Science
 Southwest Missouri State U.
 Family Practice
 Cox Medical Centers
 Springfield, MO

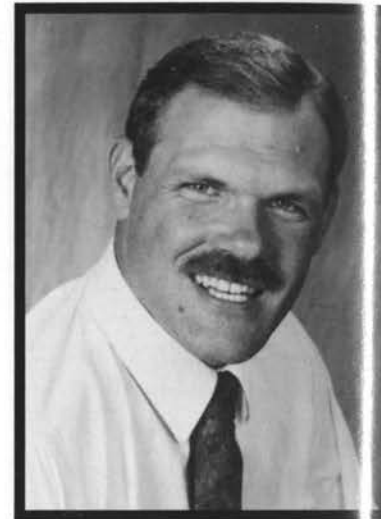
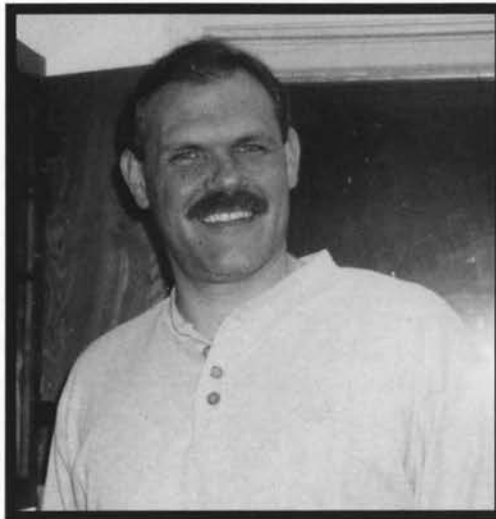

Richard David Knight, MD
 St. Louis, MO
 B.S. Biology
 University of Missouri
 Pediatrics
 Saint Louis Universtiy



*I'm goin' to
 Disneyworld!!!*

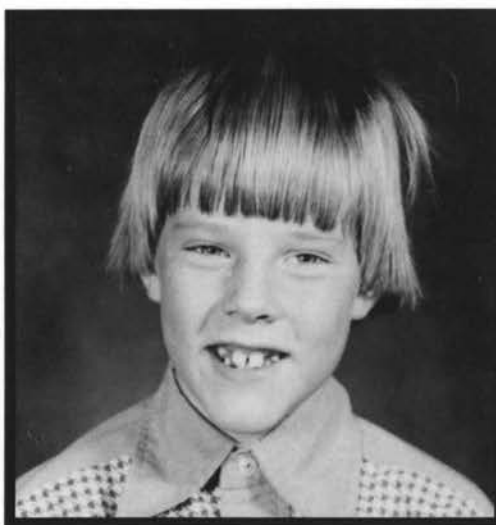

Karen Sue Knox, MD
 Southbury, CT
 B.A. Biology
 Washington University
 Pediatrics
 University of Maryland
 Baltimore, MD



*He who saves one life,
 saves the world in time.
 --Old Jewish Proverb*





Sandra Kwan, MD
 Tempe, Arizona
 B.S. Biology
 University of Arizona
 Family Practice
 University of Missouri
 Columbia, MO



Jennifer Anne LaBarge, MD
 Webster Groves, MO
 B.S. Molecular Biology
 Beloit College
 Medicine/Pediatrics
 Baylor College of Medicine
 Houston, TX



Slowly it gathers, rises from the steaming flesh until, at last, it is a pure calling--an exclusive sound, like the cry of certain solitary birds--telling that out of the resonance between the sick man and the one who tends him there may spring that profound courtesy that the religious call love.

*--Richard Selzer
 Mortal Lessons:
 Notes on the Art of Surgery*



Joel Robin Lane, MD
 Bartlett, Illinois
 B.S. Biology
 Northeast Missouri State U.
 Orthopaedics
 University of Missouri
 Columbia, MO



*Don't give up.
 Don't ever give up.
 The Jimmy V Foundation*

Gerald T. Lionelli, MD
 Granada Hills, CA
 B.S. Biochemistry
 UCLA
 Otolaryngology
 University of New Mexico
 Albuquerque, NM

*They can conquer who
 believe they can.*

--Virgil



Laura Lowry, MD
 Kansas City, MO
 Chemistry/Biology, Spanish
 Drury College
 Pediatrics
 University of Missouri
 Columbia, MO

*When you go out into the
 world, watch out for traf-
 fic, hold hands, and stick
 together.*

Be aware of wonder.

--Robert Fulghum



Nancy Carol Mabe, MD
 Florissant, MO
 B.S. Chemical Engineering
 University of Missouri
 Internal Medicine
 Thomas Jefferson University
 Philadelphia, PA

*Trust in the Lord with all
 your heart and lean not
 on your own understand-
 ing; in all your ways ac-
 knowledge Him, and He
 will make your paths
 straight.*

--Proverbs 3:5-6



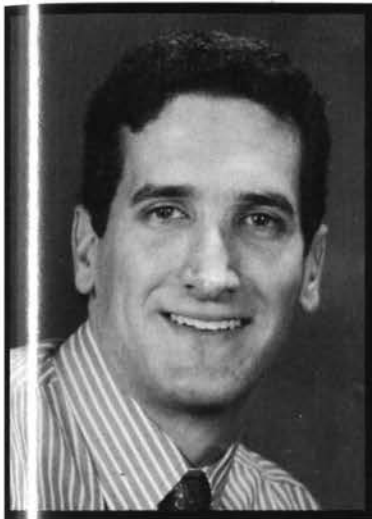

Ramsey Kevin Majzoub, MD

Joplin, MO
B.A. Biology
Saint Louis University
General Surgery
University of Iowa
Iowa City, IA



*Success is a journey,
not a destination.*

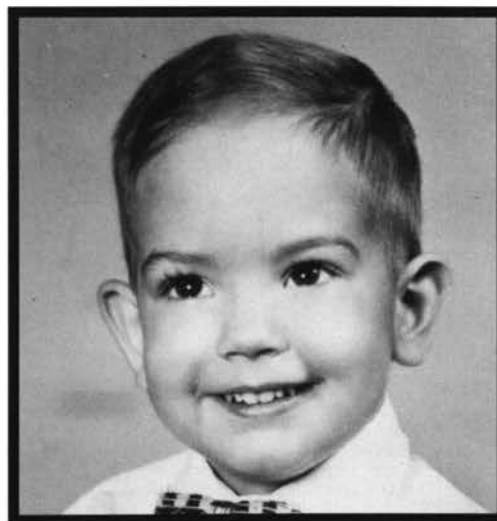

Joel P. McKinsey, MD

Springfield, MO
B.S. Electrical Engineering
Kansas State University
M.S. Electrical Engineering
Southern Methodist University
Internal Medicine
Vanderbilt University
Nashville, TN



*If we must suffer,
let us suffer nobly*

--Victor Hugo

*Far better it is to dare mighty
things, to win glorious triumphs,
even though checkered by failure,
than to take rank with those poor
spirits who neither enjoy much nor
suffer much, because they live in
the gray twilight that knows not
victory nor defeat*

--Theodore Roosevelt

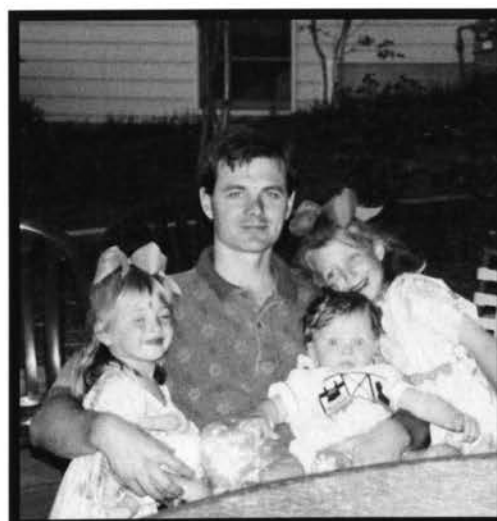
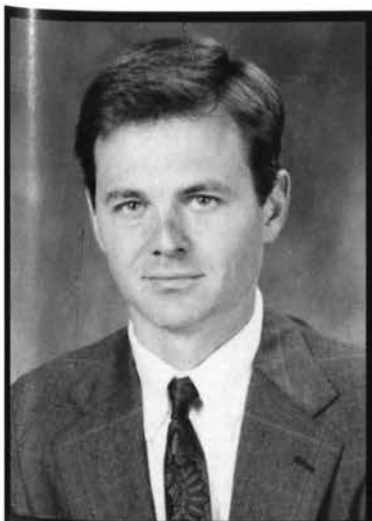

John D. Miles, MD

Columbia, MO
B.S. Mechanical Engineering
M.B.A.
University of Missouri
Orthopedics
University of Missouri
Columbia, MO



*Remember life is
never static;
all things
human either
progress or
relapse.*

Timothy M. Miller, MD

Holts Summit, MO

B.S. Biochemistry

University of Missouri

Internship

St. Joseph's Medical Center

Phoenix, AZ

Neurology

Baylor College of Medicine

Houston, TX

*Now is not a good time.
Scott G. Link*



*I want a single with a
burger.
Leslie Kenneth Lorts III*



John Mruzik, MD

Pacific, MO

B.S. General Studies

Southwest Missouri State U.

M.S. Reproductive Physiology

UMSL

Family Practice

University of Missouri

Columbia, MO

*Thank heaven for the
witness protection
program.*



Ali Najafi, MD

Gorgan, Iran

B.S. Chemistry

Southwest Missouri State Uni-
versity

Neurological Surgery

Case Western Reserve University

Cleveland, OH

*Determination today
leads to success
tomorrow.*

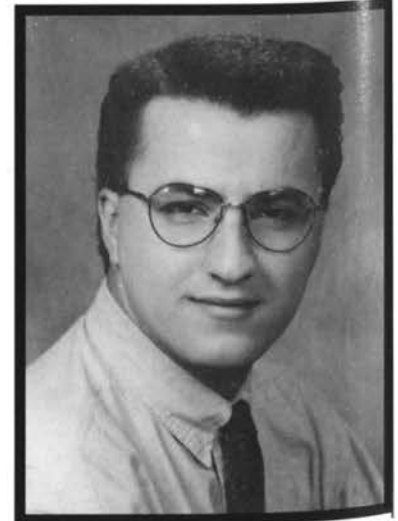



Shaban Nazarian, MD
 Kermanshah, Iran
 B.A. Philosophy and Biology
 Macalester College
 Medicine/Pediatrics
 University of Minnesota
 Minneapolis, MN



Phuong Dac Nguyen, MD
 Ho Chi Minh City, Vietnam
 B.S. Chemistry
 Lincoln University
 Family Practice
 Ohio State University Hospitals
 Columbus, Ohio



Tam Nguyen, MD
 Laguna Hills, CA
 B.S. Computer Science
 & Chemistry
 University of California--Irvine
 Medicine preliminary
 Loma Linda University
 Radiation Oncology
 University of Arizona
 Tucson, AZ



*There are no wrong
 turnings. only paths we
 had not known we were
 meant to walk.
 --Guy Garriel Kay*

Michael L. Novotney, MD

Moberly, MO
B.S. Biology & Chemistry
Southwest Missouri State U.
General Surgery
University of Washington
Seattle, WA



Jennifer Kruse Offner, MD

Palmyra, MO
B.A. Biological Sciences
University of Missouri
Family Practice
Quincy Family Practice Program
Quincy, IL

"For I know the plans I have for you," declares the Lord, "plans to prosper you and not to harm you, plans to give you hope and a future."



Holly Orr, MD
Hallsville, MO
B.A. Biology
University of Kansas
Pediatrics
Emory University
Atlanta, GA





Brett Allan Penney, MD
 Columbia, MO
 B.S. Biology
 University of Nebraska-Lincoln
 Obstetrics and Gynecology
 University of Missouri
 Columbia, MO



Life is truly a ride. I think the most you can hope for at the end of life is that your hair's messed, you're out of breath and you didn't throw up.

--Jerry Seinfeld



Susan L. Pereira, MD
 St. Louis, MO
 B.S. Biology
 University of Missouri
 Family Practice
 University of Missouri
 Columbia, MO

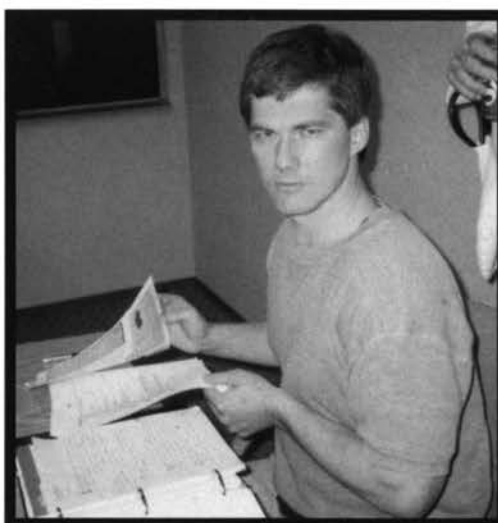

Lindall Perry, DVM, MD
 Bethal, MO
 B.S., D.V.M.
 University of Missouri
 Internal Medicine--Preliminary
 University of Virginia
 Charlottesville, VA



Janine Pingel, MD

St. Louis, MO
B.S. Biology
St. Louis University
Medicine/Pediatrics
University of Minnesota
Minneapolis, MN



Catherine F. Poole, MD

Lake St. Louis, MO
B.S. Zoology
Olivet Nazarene University
Pediatrics
Ohio State University
Children's Hospital
Columbus, OH

*He who would leap
high must take a
long run.
--Danish Proverb*



Joe Prince, MD
Springfield, MO
B.S. Biology/Chemistry
Southwest Missouri State U.
Internal Medicine--Categorical
Baylor College of Medicine
Houston, TX

*You can check out
anytime you like, but
you can never leave.
--The Eagles*

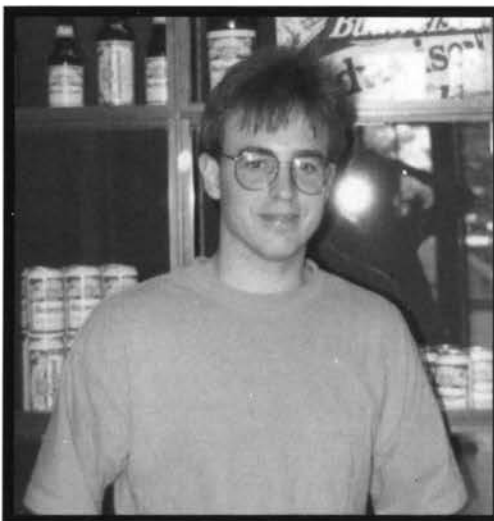



Janna Reimann, MD
 Cape Girardeau, MO
 B.S. Interdisciplinary Studies
 Southeast Missouri State U.
 Family Practice
 St. John's Mercy Medical Center
 St. Louis, MO

*In such pain, the planet
 bleeds
 From wounds inflicted
 from within
 When just the proper
 medicine
 Is all this sick world
 needs. --J.K. Reimann*



*A cheerful heart is the
 best medicine.
 --Proverbs 17:22*



Russel Reitz, MD
 Manhattan, KS
 B.S. Business
 Kansas State University
 Internal Medicine preliminary
 Radiology-Oncology
 University of Kansas
 Kansas City, KS



Caryl S. Rentz, MD
 Warrensburg, MO
 B.A. Biology
 Wake Forest University
 Obstetrics & Gynecology
 University of California
 San Diego, CA



*Your vision will become
 clear only when you can
 look into your own
 heart...who looks out-
 side, dreams; who looks
 inside, awakens.*

Sara A. Risbeck, MD

Rolla, MO
B.S. Life Science
University of Missouri-Rolla
Family Practice
University of Kentucky
Lexington, KY

*Character is higher
than intellect.
Thinking is the
function. Living is the
functionary.*

--Ralph Waldo Emerson



Martin J. Schudy, MD

Norwood, MO
B.A., Biology and Chemistry
Drury College
Internal Medicine
University of Missouri
Columbia, MO

*One fine morning in May,
a slim young horse-
woman might have been
seen riding a glossy sor-
rel mare along the av-
enues of the Bois, among
the flowers...*

--The Plague

Albert Camus

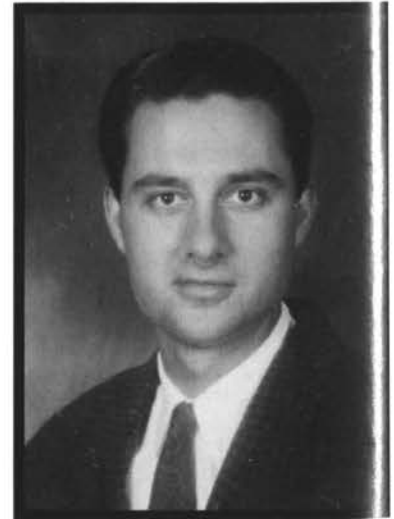

Joann Schumer, MD

Ste. Genevieve, MO
B.S. Nursing
Southeast Missouri State U.
Child Health
University of Missouri
Columbia, MO

*The purpose of human
life is to serve and to show
compassion and the will
to help others.*

--Albert Schweitzer, MD



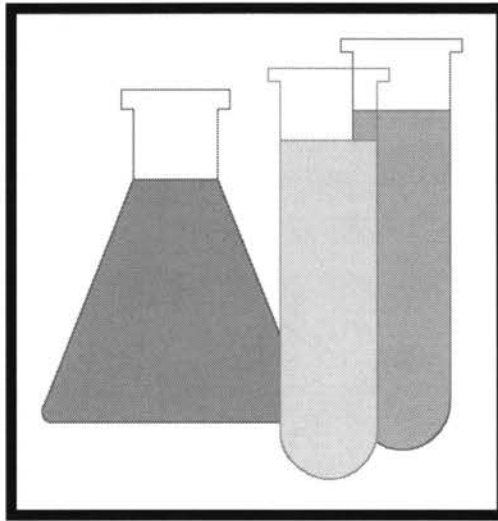

Tammie Schwager, MD

Neligh, Nebraska
B.S. Zoology
Southeast Missouri State U.
Medicine
Methodist Hospital
Dallas, TX



Wesley D. Scoles, MD

Joplin, MO
B.S. Biology
Pittsburg State University
Family Practice
University of Missouri
Columbia, MO



The constitution of the Republic should make provision for medical freedom as well as religious freedom. To restrict the art of healing to one class of men and deny equal privilege to others will constitute the bastille of medical science.

--Benjamin Rush



Laurie Day Senol, MD

West Caldwell, New Jersey
B.A. Liberal Arts & Sciences
Virginia Polytechnic Institute and
State University
M.S. Computer Science
Washington University
Internal Medicine
St. John's Mercy Medical Center
St. Louis, MO



Deanna Maria Siemer, MD

Jackson, MO
Psychology, Biology Minor
University of Missouri
Family Practice
University of Missouri
Columbia, MO

*The treatment of a disease
may be entirely imper-
sonal; the care of a patient
must be completely per-
sonal.*

--Francis Weld Peabody



Nolan Carroll Snider, MD

Cedar Gap, MO
B.S. Interdisciplinary Studies
Southeast Missouri State U.
Family Practice
Cox Medical Centers
Springfield, MO

*Will be is Will be ,
and Is is Is,
Don't live for the Then,
Shunning the Now,
For Yesterdays are
Forever,
And Tomorrows
may be Nevers.*

*--Carpe Diem
N. Snider 4/93*

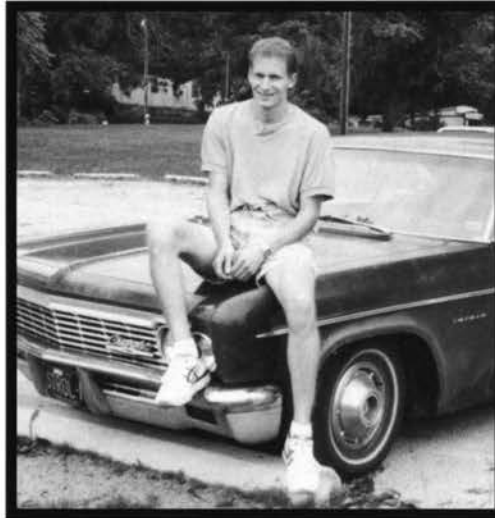

Donna Steffen, MD

New Bloomfield, MO
B.A. Biology
Westminster College
Family Practice
Selma Family Medicine Resi-
dency
Selma, Alabama

*Noneé cares and
Noneé knows*

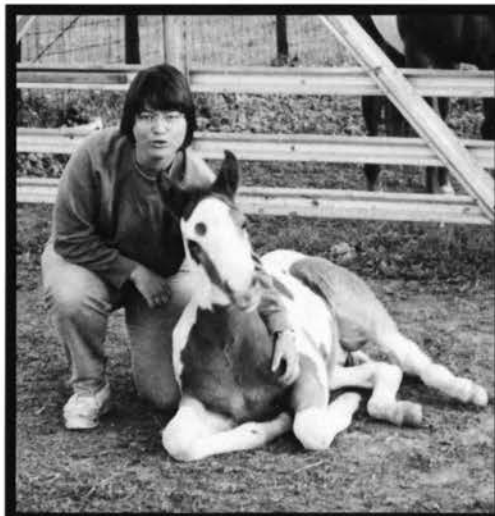



Danielle Sabrine Stranc, MD

Temple City, CA
B.S Biology
Cal State Los Angeles
Transitional Year
St. John's Mercy Medical Center
St. Louis, MO
Anesthesiology
University of Texas - San Antonio
San Antonio, TX



Paula Stuebben, MD

Edina, MO
B.A. Biology
University of Missouri
Pediatrics
University of Missouri
Columbia, MO



*I chose Pediatrics so that
I could be taller than 50
percent of my clientele.*



Sharif Tarazi, MD

Kandahar, Afghanistan
B.S. Chemistry
Washington University
Surgery - Preliminary
U. of Southern California
Los Angeles, CA



Rajiv Thakur, MD

St. Louis, MO
B.S. Biology
University of Illinois - Champaign
Transitional Year
Deaconess Hospital
St. Louis, MO
Radiology - Diagnostic
Northwestern University
Chicago, IL



Lisa Thomas, MD

Des Peres, MO
B.A. Clinical Psychology
Washington University
M.S. Clinical Psychology
University of Missouri
Psychiatry
University of Missouri
Columbia, MO



Ronnie Thomas, MD

Mt. Pleasant, TX
B.S. Animal Science
M.S. Reproductive Physiology
Texas A & M University
Family Practice
University of Missouri
Columbia, MO

*The race is not always
won by the fastest,
But sometimes by the
one who keeps running.*

Don't ever give up!

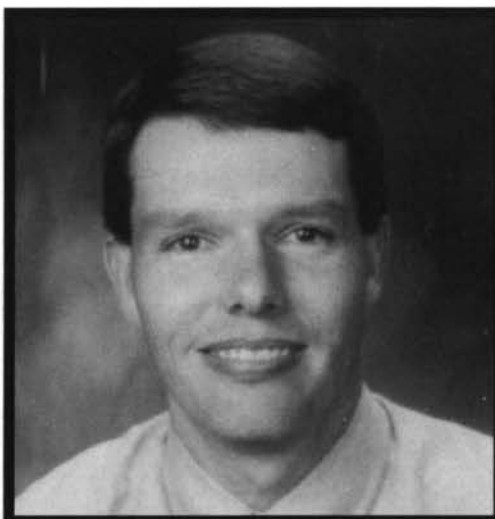



Kimberly Thomasson, MD

Benton, KY

B.S.N.

University of Kentucky
Internal Medicine

University of Tennessee
Nashville, TN

*When thou passest
through the waters, I
will be with thee; and
through the rivers, they
shall not overflow thee:
when thou walkest
through the fire, thou
shalt not be burned; nei-
ther shall the flame
kindle upon thee.*

Isaiah 43:2

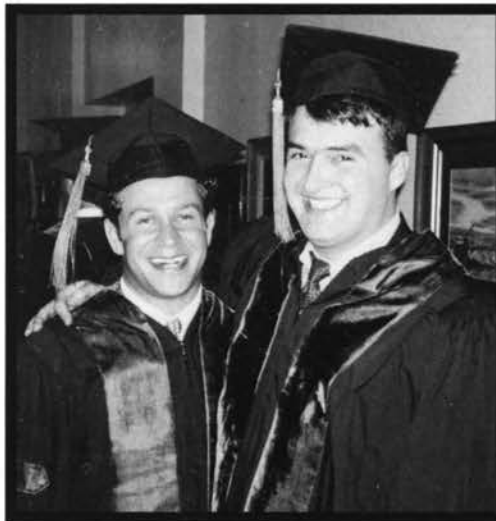
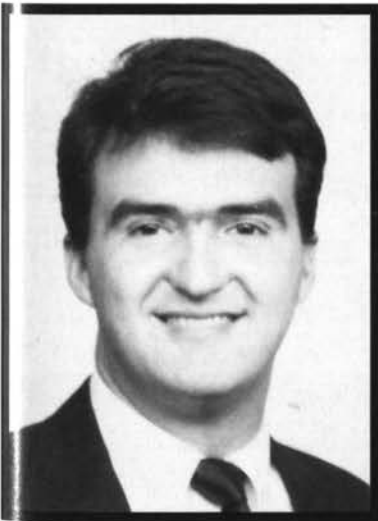

Jeffrey B. Thompson, MD

Clayton, MO

B.S. Mathematics

Vanderbilt University

Obstetrics and Gynecology

Washington University

St. Louis, MO

*There are only two kinds
of people who are really
fascinating--people who
know absolutely every-
thing, and people who
know absolutely nothing.*

--Oscar Wilde



Terence Thompson, MD

Los Angeles, CA

B.S. Biochemistry

UCLA

Family Practice

Northridge Hospital Medical Center

Northridge, CA

*I can do all things
through Christ
who strengthens me.*

--Philippians 4:13



Kay Anne Tipton, MD

Kansas City, MO
B.S. Biology & Chemistry
William Jewell College
Liberty, MO
Pediatrics
University of Texas
San Antonio, TX



*Many are the plans in a
man's heart, but it is the
Lord's purpose that
prevails.*

--Proverbs 19:21



Sarah Tipton, MD

St. Louis, MO
B.S. Business Administration
Washington University
Diagnostic Radiology
University Hospitals of Cleveland
Cleveland, OH



Chris Tocco, MD

St. Louis, MO
B.S. Humanities & Science
M.I.T.
Emergency Medicine
Northwestern University
Chicago, IL





Tuongvan T. Tran, MD
 Kansas City, MO
 B.S. Biology & B.A. Chemistry
 UMKC
 Family Practice
 Truman East Hospital
 Kansas City, MO



Steven Jay Tucker, MD
 Clayton, MO
 B.A. Chemistry
 Indiana University -
 Bloomington
 Internal Medicine
 UCLA Medical Center
 Los Angeles, CA



*Chance favors the
 prepared mind.*
 --Louis Pasteur

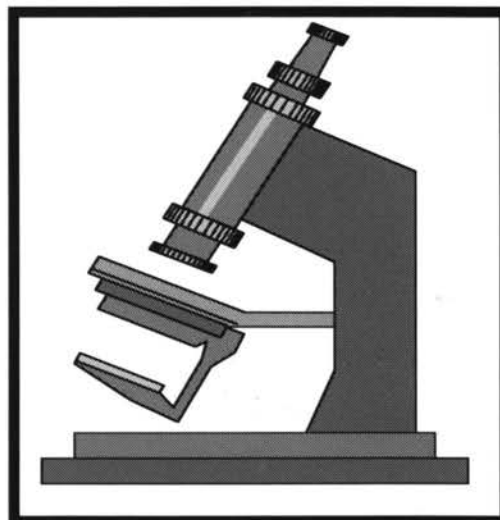

Jennifer Tuteur, MD
 St. Louis, MO
 B.A. Socioecology
 Yale University
 Family Practice
 St. Paul-Ramsey
 St. Paul, MN



Kristen Dawn Udell, MD

Ash Grove, MO / Eugene, OR
B.S. Biology
Southwest Missouri State U.
Family Practice
Scott Air Force Base
Belleville, IL



*The Lord is my strength
and my song
--Isaiah 43:2*

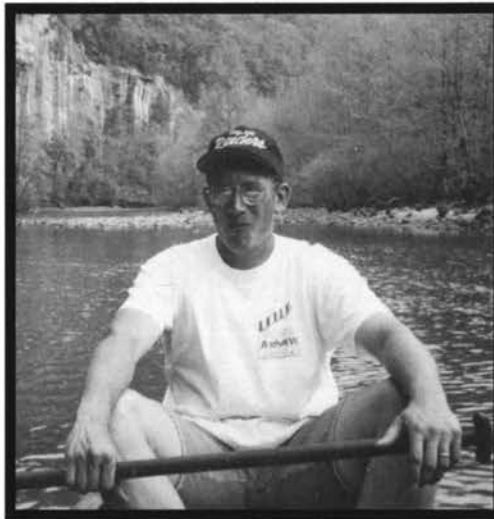

Mark Wakefield, MD

Abilene, TX
B.S. Zoology
University of Texas at Austin
Urology
University of Missouri
Columbia, MO



*The anatomy lab is the
only place where I wash
my hands before going
to the bathroom.
--Dr. Thomas Scanlon*

*...And after eating hot
wings.
--MRW*



Stevan Patric Whitt, MD

Bakersfield, CA
B.S. Zoology
Northwest Missouri State U.
Internal Medicine
University of Missouri
Columbia, MO



*Happiness is a good
family, good friends, a
meaningful career, and
a workshop.
--Steve Whitt*

*Some of it's magic, some
of it's tragic, but I had a
good time all the way...
--Jimmy Buffet*

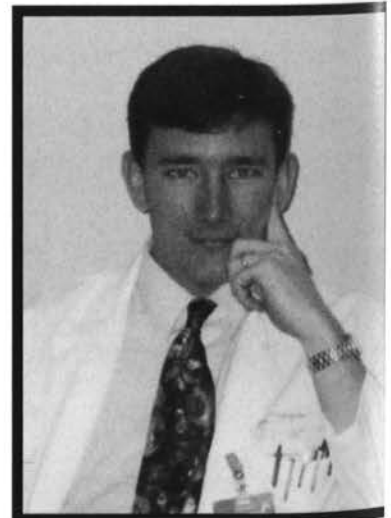



DeDe Willis, MD
 Quincy, IL
 B.S. Biology
 Northeast Missouri State U.
 Family Practice
 University of Missouri
 Columbia, MO



*Physicians are only
 nature's assistants.
 Never go to one whose
 office plants are dying.*
 --Smallwood



Elaine Wills, MD
 Durant, OK
 B.S. Biology
 Texas A & M University
 Family Practice
 East Tennessee State U.
 Bristol, TN



*Don't give up,
 don't ever give up.*
 --Jim Valvano



Nancy Sue Witt, MD
 St. Louis, MO
 B.S. Biology, B.A. Psychology
 Emory University
 Internal Medicine
 Northwestern University
 Chicago, IL



Roger Woods, MD
 Poplar Bluff, MO
 B.S. Zoology
 Southeast Missouri State U.
 Family Practice
 University of Tennessee
 Jackson, TN



Not Pictured:

Michael Maurizi Laurie Mclemore

And the envelope, please...

Specialty Distribution:

Family Medicine	27	Radiology	3
Internal Medicine	17	Radiation Oncology	2
Pediatrics	11	Neurology	1
Obstetrics/ Gynecology	9	Neurosurgery	1
General Surgery	5	Otolaryngology	1
Emergency Medicine	4	Pathology	1
Medicine/ Pediatrics	4	Plastic Surgery	1
Psychiatry	4	PM&R	1
Anesthesiology	3	Urology	1
Orthopedics	3		

Geographic Distribution

Missouri	38	Florida	1
Columbia	25	Georgia	1
Texas	8	Kentucky	1
California	7	Maryland	1
Illinois	7	Michigan	1
Ohio	7	Nebraska	1
Tennessee	6	New Mexico	1
Minnesota	5	North Carolina	1
Indiana	3	Pennsylvania	1
Alabama	2	Virginia	1
Iowa	2	Washington	1
Kansas	2	Wisconsin	1

Class of 1994



Tama Franklin likes to have her photograph taken.



Joel McKinsey makes his move on Janine Pingel, who wonders where Shaban could be hiding.



Sara Holland is:
Sassy



Pre-Match Bash: held to help relieve anxiety, not!

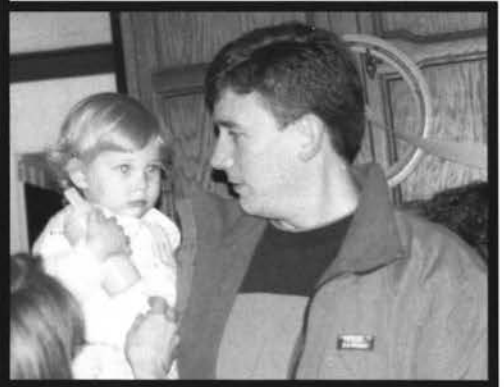

Steve Whitt asks:
"Do you need more beer in your bottle?"

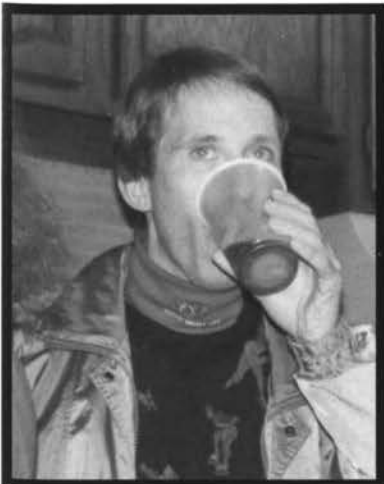

Jamie Hileman demonstrates his olympic training form.



Sue Pereira examines the man across the street for dermatologic lesions.



Sarah Tipton happily breaks away from Jamie.

Match Day



Nervous?...Who, us?



The adoring masses...or
"I hope they don't match here."



Any minute now,
the envelopes
will arrive...



A Diet Coke to calm the nerves.



An early neurosurgery match means Ali's not
the least bit nervous.



Laura & Kim practice
smiling so they can feign
joy if necessary.



Sandy's new baby Ivey joins Heidi, Kim, & Sara
to hear the results of the match.



Rick is more nervous about the upcoming
Lounge Lizard elections than the match.



Steph's eager to
get her envelope.



Chris and Mark Hicks.



And the Winner is.....

Class of 1994



Janine looks happy!



San Diego!!!



Good News !



Patty is psyched, Hugh starts to put out the spin to the reporters...



...and Mitch explains the sensitivity and specificity of his match predictions to anyone calm enough to listen.



"Come on, Tama, let me see your envelope."



Joel Lane explains to Joel and Steve that he wasn't nervous about his match.



Lindall...?



"I told you we should have couples matched!"



Roger and his family enjoy new found noteriety and Roger considers ditching this residency thing to vie for Paul Pepper's job...



Dr. Groshong and Jenny discuss Baylor.



"That'll get alot of play don't you think -- 'a doctor in L.A. with a red sports car?'"

Match Day



Steve wonders if Sharon will be able to get Bluedevil tickets.



Some M3s congratulate (and envy) matched M4s.



Sara, Alex, Sandy, and Cathy pose for another photo.



Now, Tom and Susan can safely ponder a new car, a new home, and even marriage.

Sue and Janine can not believe that Jeff actually wanted to go to Wash U.



Dana, Chuck, and Caleb celebrate a successful match day.

March 16, 1994



Local reporters have a feeding frenzy with match day interviews.



Dan enters his match list a little late!

Class of 1994



Dan and Jason admire
Laura's new set of beads.



Chris Tocco shows off
his interview attire.



"No, it's not exactly a 'penis doctor.'"



Paula encourages Dave
to fill her glass
all the way to the top.



Post-Match Celebration at Les Bourgeois Winery



Joe and Tam toast
liver transplants.



Elaine catches a nasty
virus at the winery.



Too bad for Tom, Raj, and Rob:
facial hair is inversely proportional
to scalp hair.

Match Day



Dave asks De De to share some wine.



The key to a successful proposal-- pink fox!



Sara and Flip sport their matching shades and "his and hers" T-shirts.



"These Missouri wines aren't half bad!" explains George Castanza, "much better than the swill I serve..."



Joel and Laura enjoy the sun and wine.



Paula : "Get your own bottle!"



Peter, freshly awakened from an afternoon nap, sports call-room bed-head.

Class of 1994



Jamie is surprised that people think that he is a brown-noser.



Mike is amazed that such cruel jokes are being made about his classmates (by someone other than Peter).



John excuses himself to make a quick call on his cellular phone to a special M3.



Denise, Erin, and Sheri: "We'll miss this group...NOT!!!"



Shannon announces that he will no longer offer a shuttle to Springfield.



Tom, Tim, Raj, and Rob close the show at Deja Vu.



Laura Lowry, with a slight tremor, discusses the etiology of projectile vomiting.



Bill Bentz asserts that he is not from Arkansas and that he is not related to the Clintons.

Senior





Snapshots

Graduation Activities



Hard working farm boy!



Cathy and Kim enjoy the soup.



Sherwin and one of the



twins wait for the fire.

If you build it, they will come...



Paula, De De, and Elaine wash down the last bit of soup.



"Anyone want to try some turtle soup?"



Joel usurps the cooking duties from the many willing cooks.



The Class of 1994 prepares to burn (or melt) their short white coats.



Homage is paid to the coat and the sweat smell of burning *Pseudomonas*.



Thanks to the Orrs!!!

The Bonfire 1994

The Pig Roast



Paula finally brings Stan to a class function.



May 8, 1994



If you roast it, they will come...



Janine explains that she lets Shaban win.



Chris looked at the pig and said, "better you than me!"



"Dan, aren't you on a block this month?"



Steve pauses to ponder the force of gravity.



Despite a grueling externship, Deanna sports some well tanned legs.



"I read about training puppies in the latest 'Good Housekeeping'"

Cardinal Baseball Game



Loading the *Magic Bus!*



For some reason, the lines at the rest stop were quite long.



The good students at the Science Center:



Sally found the perfect opportunity to unload some cups.



Danielle -- lost in paradise



The new Bud Girls!

Homer Simpson, eat your heart out!





Laura and Chris applaud the game winning homerun in extra-innings.



Sharla, Sally, and Jill admire the anatomy of the Clydesdale Horses.



"You mean, we can *finally* go home..."



"Hey, the Cobra isn't half bad!"



"They only serve O'Doul's after the seventh inning..."



Who's the designated driver?



Jill shows the way they eat nachos at SMU.

Banquet

For some reason, Rob is more interested in Candise.



De De takes a little rest .



Dan and Sue savor a fine cup of grape juice before the banquet.



Be Afraid. Be Very Afraid.



Laura and John



Peter and Kate



Stuart and Karrie



Nancy and Dan

May 12, 1994



Still gloating after winning the "Lounge Lizard", Rick looks for a couch.



Dave and Caryl Rentz.



Chris and Stephanie are still overwhelmed by Dr. Adelstein's speech.



Cathy Poole, Elaine Wills, and Kim Thomasson.



Sara (Nice Braid) Holland, Nancy (Small Ring) Witt, and Jill (Practiced Smile) Henley.



Janna and her man.



Bill and Barb



Roger and Barb



Chris and Mark

The Class of 1994



May 14,



Dr. Groshong:
"Now, who are you?"



The last row.



Bill has a smirk --
they can't touch him after today.



Jenny
and Joel,
any special
news for
today?



Martin
and
Joann
think
fondly
of their
days
with
cadavers.



Graduation!



1994



Dean Bryant and a group representing the majority gender from the Class of 1994.



Officers of Investiture:

Jan Swaney, MD,
Mitch Rosenholtz, MD,
Ann Havey, MD.



Dr. McCallum:
I can't believe that these people
are going to be physicians.



Dr. Adelstein hopes that he
doesn't pass a kidney stone
while on stage.



"And after this,
we need to finish that damn yearbook."

Honors and Awards for the Class of 1994

Honors

American Medical Women's Association Janet M. Glassgow Memorial Award
Dean's Award for Academic and Clinical Proficiency
The Holt Leadership Award
The Student Leadership Award
Joseph E. Flynn Memorial Scholarship

Caryl Rentz
Lindall Perry
Joel McKinsey
Joel McKinsey
Lindall Perry

Departmental Awards

Parker B. Francis Award for Excellence in Anesthesiology
Robert L. Jackson Award for Outstanding Performance in Pediatrics
Family Practice Award
Outstanding Achievement in Internal Medicine
Dermatology Outstanding Student Award
Outstanding Student in OB/GYN
John Aure Buesseler Award for Excellence in Ophthalmology

Jane Caldwell
Chris Hicks
Deanna Siemer
Lindall Perry
Nancy Witt
Caryl Rentz
Sharon Curtis
Jamie Hileman
Sherwin Imlay
Barb Howard
Mark Wakefield
Lisa Thomas
Sarah Tipton
Heidi Chua
Ali Najafi
Joel McKinsey
Joel Lane
Barb Howard
Mark Wakefield
Heidi Chua

W.B. (Pete) Stewart Memorial Pathology Award
Howard A. Rusk Memorial Award
Outstanding Student Achievement in Psychiatry
James D. Dexter Award for Excellence in Neurology
Radiology Award for Outstanding Achievement
General Surgery "Marion S. Deweese Award"
Samuel P. Black Prize for Excellence in Neurosurgery
Otolaryngology Award for Excellence
"Mizzou" Orthopaedic Award
"Outstanding Student Seminar in Plastic Surgery"
Urology "Ian M. Thompson Award"
Vascular Surgery Award

Other Honors and Awards

Family Health Foundation of Missouri Award
Lange Medical Publication Student Award
Upjohn Achievement Award

Sue Pereira
Sherwin Imlay
Caryl Rentz

AMWA's Janet M. Glasgow Memorial Achievement Citation

Sally Bomar
Heidi Chua
Barb Howard
Jenny LaBarge
Nancy Mabe

Missouri State Medical Association Award for
Outstanding Achievement in the Study of Medicine

Heidi Chua
Barb Howard
Mike Novotney

American College of Emergency Physicians'
R.R. Hannas, M.D., Emergency Medicine Award
Society for Academic Emergency Medicine's
Excellence in Emergency Medicine Award

Chris Tocco
Chris Andershock

Boone County Medical Society Alliance's Award for
Outstanding Performance and Academic Excellence

Nancy Mabe

American College of Physicians' Jan Swaney, M.D., Book Award

Steve Whitt

Student National Medical Association Graduation Recognition Award

Joe Castrejon
Sharon Curtis
Alex Garcia
Laurie McLemore
Elaine Wills

Scott A. Willis Memorial Scholarship
James L. Chapel Scholarship
Elfriede Tachman Memorial Award

Tim Miller
Mark Wakefield
Sally Bomar

Summa Cum Laude

Heidi Chua
Nancy Mabe
Mike Novotney

Lindall Perry
Caryl Rentz

Magna Cum Laude

Sally Bomar
Jamie Hileman
Barb Howard
Sherwin Imlay
Shannon Kelly

Jenny LaBarge
Ger Lionelli
Mark Wakefield
Nancy Witt

Cum Laude

Chris Andershock
Bill Bentz
Jane Caldwell
Patty Hoffman-Calvo
Stephanie Carron
Karrie Cunningham
Brian Deem
Dana Eissler
Karen Franklin
Jill Henley
Chris Hicks
Laura Lowry

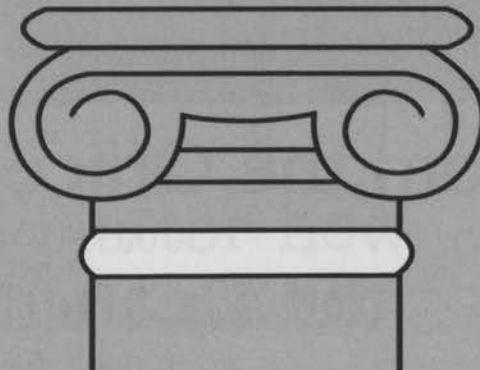

Ramsey Majzoub
Mike Maurizi
Joel McKinsey
John Miles
Tim Miller
John Mruzik
Ali Najafi
Joe Prince
Deanna Siemer
Terence Thompson
Chris Tocco
Steve Whitt

Congratulations

**to the
Class of 1994**



**From the Office of
the Dean**



Did It!
Had It!
Flunked It!
Wrote a Paper!

Congratulations Class of 1994 - On A Job Well Done !!
 From The Class of 1994

There are some things
 we will never forget.



No matter how
 hard we try!

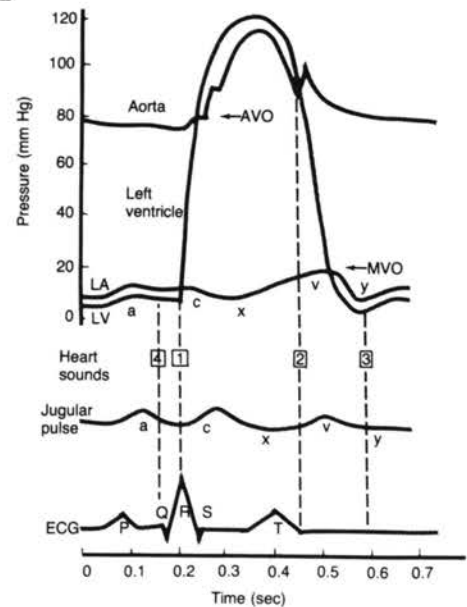

CONGRATULATIONS

TO THE CLASS
OF 1994

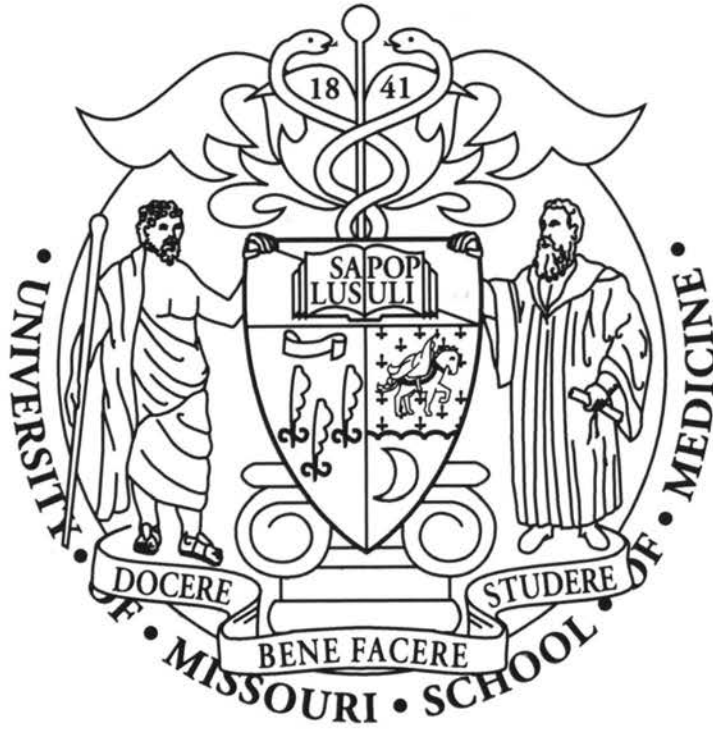

MEDICAL ALUMNI ORGANIZATION
MEDICAL SCHOOL FOUNDATION

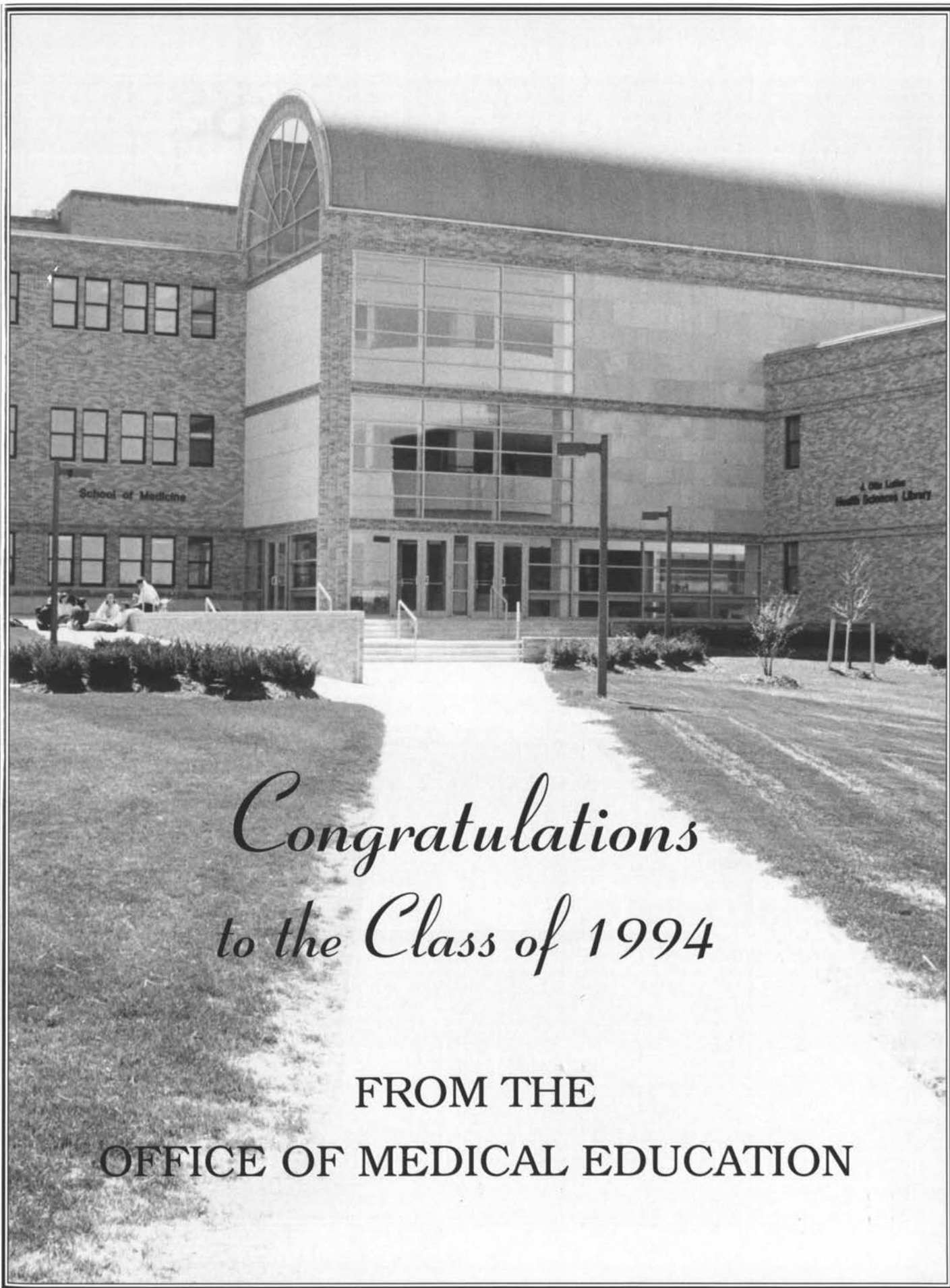

*Congratulations
to the Class of 1994*

FROM THE
OFFICE OF MEDICAL EDUCATION



Congratulations to the
Class of 1994
from the
Department of Internal Medicine

Congratulations from the Boone Platoon



Boone Hospital Center
1600 East Broadway • Columbia, Missouri • 875-4545

CONGRATULATIONS Graduates !!

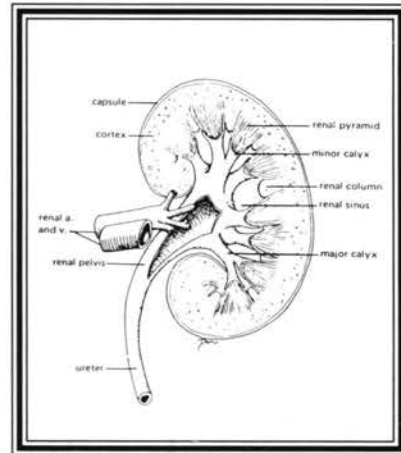

*from the Division of
Nephrology*



Children's Hospital

at University Hospital and Clinics Columbia, Missouri

*CONGRATULATIONS
TO THE CLASS
OF 1994
FROM THE
DEPARTMENT
OF CHILD HEALTH*



C O N G R A T U L A T I O N S

CLASS OF 1994

FROM THE DEPARTMENT OF
OPHTHALMOLOGY



Department of Physical Medicine & Rehabilitation

5R01 Rusk Rehabilitation Center, One Hospital Drive, Columbia, MO 65212
Phone: (314) 882-3101 Fax: [314] 882-4540

Dear 1994 graduates,

*We enjoyed our association
with you. If we can be of
service to you or your patients,
please feel free to call on us.*

*We wish you much
success and happiness!*

*Sincerely,
The Faculty and Staff*



Department of Physical Medicine & Rehabilitation

5R01 Rusk Rehabilitation Center, One Hospital Drive, Columbia, MO 65212
Phone: (314) 882-3101 Fax: [314] 882-4540

Inpatient programs include:

- *Amputee*
- *Head Injury*
- *Arthritis*
- *Pediatric*
- *Spinal Cord Injury*
- *Chronic Pain Management*
- *Stroke*
- *All types of Neurological & Musculoskeletal*

Outpatient programs include:

- *Augmentative Communication*
- *EMG Lab*
- *Biobehavioral*
- *Brain Injury Rehabilitation - Day Program*
- *Work Injury*
- *Children's Assessment Services*
- *All programs listed under Inpatient*

To make a patient appointment or to speak with one of our physicians or psychologists concerning a patient, call 800-877-7197 (ext. 3101).

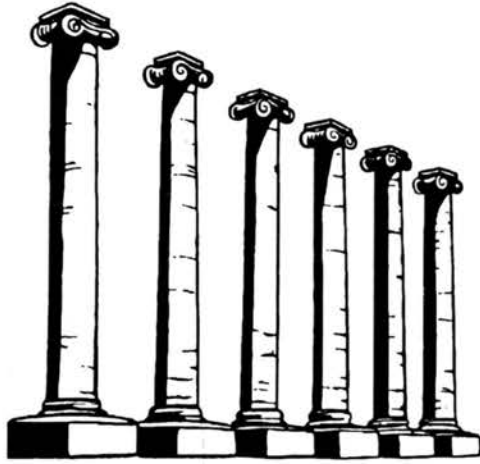

*"Wherever the art of
medicine is loved, there
is also love of
humanity."*

Hippocrates

Congratulations to the Graduates of the Class of 1994

*From the faculty and staff
of the
Department of Surgery*

***Congratulations
Graduates!***



The world is
your microscope

From the Department of
Molecular Microbiology & Immunology

**Best Wishes From
The Department of
Anesthesiology**



*Go Get 'em
Graduates !!!*

MSAC

Congratulates the
Class of 1994
& Thanks the
Medical School
Foundation,
Weldon Webb, and
Roberta Settergren



Congratulations
Class of 1994

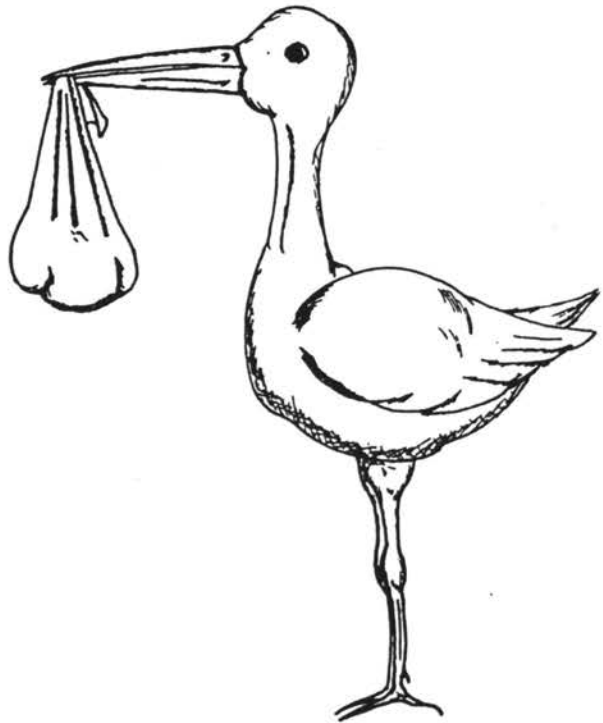

From the
Department of
Obstetrics and
Gynecology

Congratulations
to the
Class of 1994

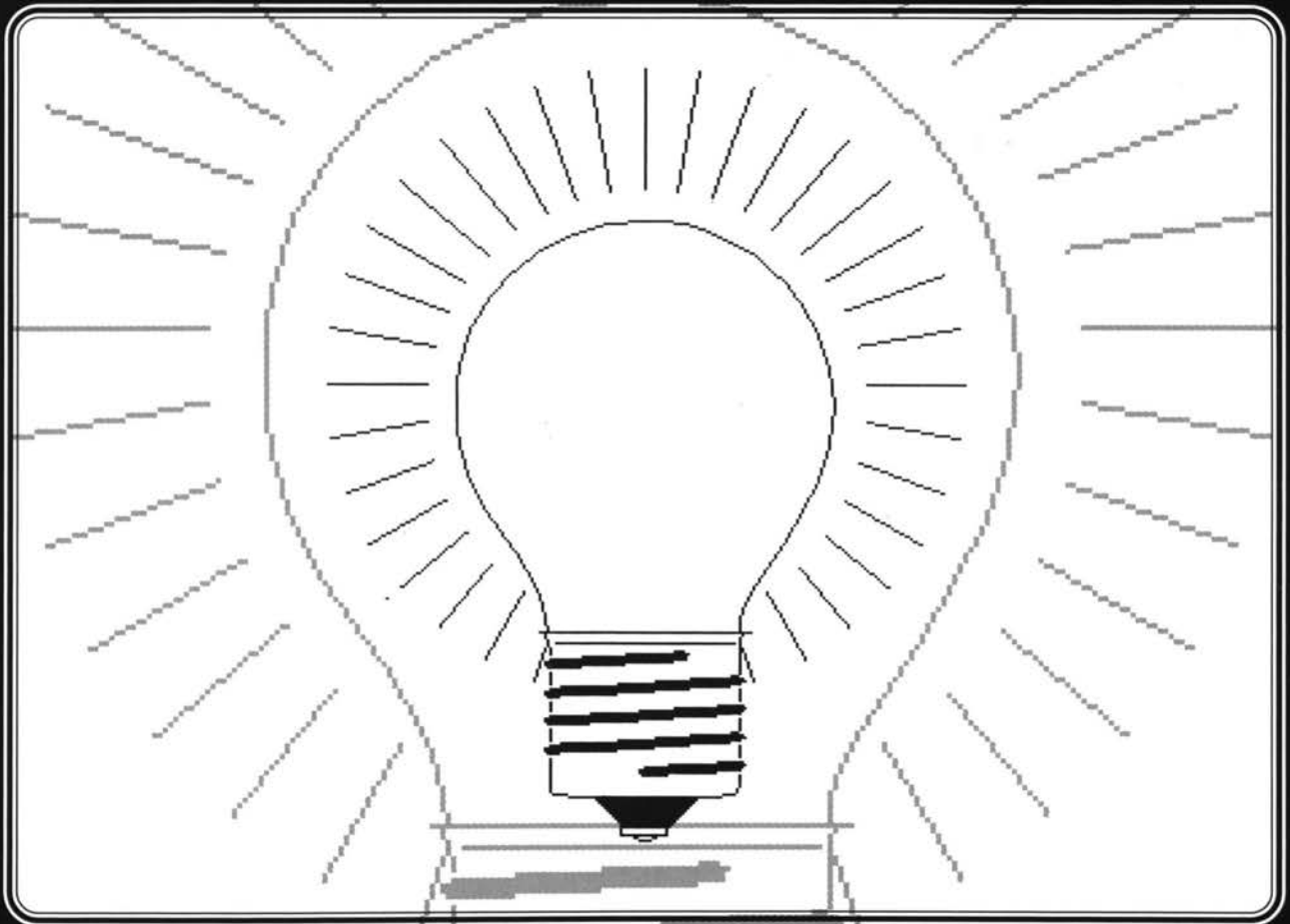

From the Department
of Radiology

The Staff for life

CONGRATULATES
the Class of 1994
medical school
graduates.



University Hospital & Clinics
Ellis Fischel Cancer Center
Rusk Rehabilitation Center
Children's Hospital

**Congratulations
to the
Class of 1994**

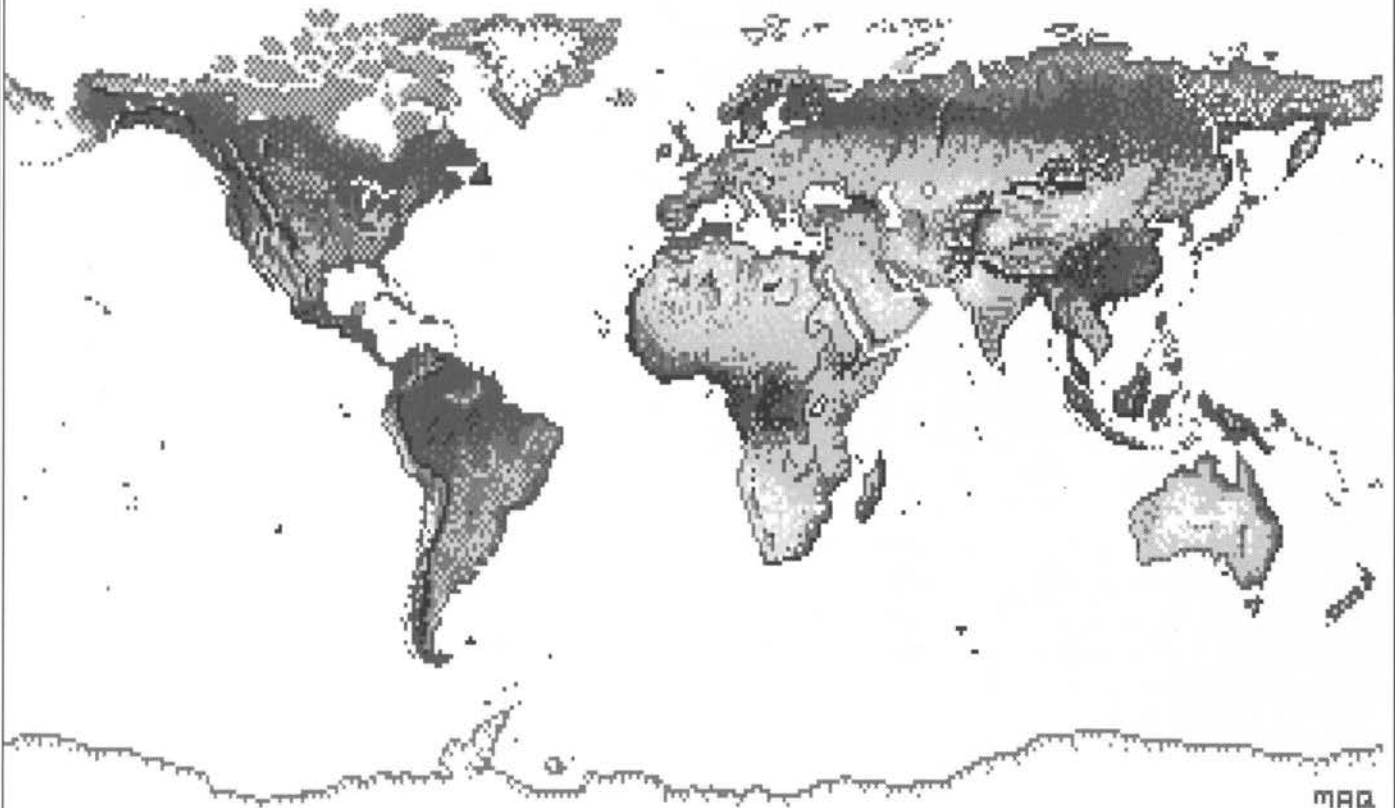

All the world is yours!

**The Department of
Psychiatry & Neurology**

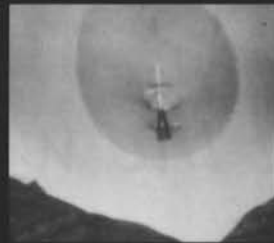



←
Family & Community
Medicine

→
Cardiothoracic Surgery
Otolaryngology
Anesthesiology





EDITOR'S PAGES

When I was awakened from a sleep about two years ago and given the "big sell" to take over as yearbook editor, I refused to do it alone. I had seen how much work it was and I did not want it all on my back. Steve was the obvious choice (as the only other person from our class involved in yearbook at that time, and as a friend who I thought I liked enough to work with for so many hours). I had to give him the "big sell" to help me out. I felt compelled to be involved as an editor of *MU*tion

because I truly (as corny as it sounds) had strong compassionate feelings about the *MU*tion. I went to a huge high school (Hickman) a huge university (U of MO) and had never felt the comraderie in school that I did in med school. The *MU*tion was the first yearbook I had been able to pick up since junior high where I knew most of the people in it and had been to most of the functions depicted. I wanted our yearbook to continue to be great. I think it was that passion that made me say "yes" to a job which was overwhelming, thankless, and fraught with financial instability.

There are two reasons, when I look at the big picture of life, that I am thankful I said "yes". One is that it provided lots of time to become even closer friends with Steve ("Castanza") and Mark Wakefield ("Moonpie") who are two of the finest, funniest people I have ever had the honor of knowing. The other reason is that I think we did do a good book and I think we left the *MU*tion better than we found it. One obvious improvement we made is that we brought the *MU*tion (and me, for that matter) into the 1990s by diving into desktop publishing. The computer makes a better product, is easier to use (making it more fun for the staff) and saves money in the long run by allowing a discount on publishing costs. The computer is a legacy we are proud to leave behind. The other main contribution we made was to avoid spiraling debt by not spending money without conscience or neglecting fund-raising. This was mostly Steve's doing. He networked, schmoozed, and made cold calls like a wild man. He was able to increase sponsorship way above any in the recent past.

We owe a debt of gratitude to many. Thanks to the patrons and sponsors for their generous support, MSAC and FAMS for having faith in our computerization vision and making it all possible, the advertisers for their interest, the Dean's office and Erin in particular for helping us with just about anything we asked for, Weldon Webb and the Medical School Foundation who were so helpful with financial, computer, and moral support, the anatomy department for the continued use of their darkroom and to all the students who took interest in and helped with the yearbook.

We had a great staff this year, and I appreciate everyone who pitched in. A few in particular stand out: Denise, for guidance, for calmly putting up with some of my more manic moments, and for always agreeing to pick up the pieces whenever I flailed; Hector, for going above and beyond what was expected (most likely candidate for editor *MU*tion '97--don't forget to hit me up for support, dude); John Sears (as usual), Kim Thomasson, Jane Caldwell, Steph & Keith, Danielle, Sharla, and Laura DenOuden who all took or donated tons of pictures. Kudos also to the many people who I'm forgetting and those who just lended a hand and made things more fun like Heidi, Nancy, Holly and Jill.

I know the book's not perfect, and I take 100% responsibility for any jokes that offend. I have seen almost every page of this book prior to publishing and the only tasteless jokes I allowed I honestly did not think would offend those they were made about, or overly offend any of the usual readers. Let me assure you, much of the *MU*tion is done late-at-night, with-lack-of-sleep, after-some-libations, so I did have to use my editorial veto power on many occasions, and at times had to be stifled myself.

Mark Wakefield is as responsible, if not more, as Steve and I are for the quality of this year's *MU*tion. Not only did he do as much work as us and know more about what needed to be done, he was always a great motivating force. If you never got to know him, it was your loss. He is an exceptional person.

Well, if you're still reading, I hope everyone likes the 1994 *MU*tion. I think we made something we can be proud of. I hope it gives you a few laughs and serves as an accurate file of memories from your med school years. I'm already starting to look back fondly on them. Hey Moonpie, last one at the Fisch is a rotten egg! (I may eat those words...)

IRIE, *Sara Holland Crowder, MD*

P.S. Personal thanks go to my mom, Flip, Maubee & Felix for all putting up with me and the strife this book caused. And as always, thanks to Jagermeister for making life's little ups and downs more bearable....



RIGHT:
"Who's
that
in
your
pocket?"



EDITOR'S
PAGES

Editors Notes-1994: We made some great changes with the MUTation this year, namely computer layouts and financial resurrection. It is only appropriate that I am writing my Editors Page on E-Mail from UCLA, to send, to Sara, in Galveston, to get printed in Missouri. I want to use this space to thank everyone who helped Sara and I get the MUTation going. I will never succeed in thanking everyone deserved of thanks and I apologize for any omissions. First and foremost I thank Sara for picking me up every November morning during Neurosurgery, aside from that she was kind of a bother. OK so I am kidding, The yearbook you are holding could not have been done without Sara's efforts, she truly tackled a bigger job than most people know. Second, I have to thank Dr. Wakefield and his OC habits. Go back and check the surgery layouts, the man is a genius with a Mac. Mark, the only other thing you could have done was write my editors page (read-does not finish the job he starts!). Really, thanks Mark. Additionally, I want to thank Denise for picking up the pieces after we left in May. Are you ready to talk to us yet? I can't wait to see her yearbook, it's going to be amazing.

MUTation really turned in the right direction this year and a great deal of credit goes to Weldon Webb and the Medical School foundation. I found a great resource in Weldon, Sue Duncan, and Marguerite Kiley. I can't forget Dr. Stephenson, thanks for all the great talks. Dr. G.- glad to know you bought a book, keep it up! Erin - what can we say, we want you on the MUTation payroll (like we can afford it, Hey Weldon!). Also, Drs. Groshong and McCallum, thanks for being such strong advocates, you helped us on more than one occasion. Roberta, don't think we forgot you, you were a lifeline for us. You always knew who to call, or how to get it done, and where the department checks were.

The financial turn around at MUTation was not done by wise investing on our part, it was done by wise investing from the clinical departments. I thank all of the departments who bought advertising. I especially thank all of the sponsors and patrons; you were the financial backbone we needed this year to turn things around. Do not let the 1995 MUTation down. We saw a record increase in the number of supporters and I encourage more of you to give this year (If Sara and I can do it on intern salaries, so can you!)

My friends, the few ones left. Thanks for all the help; Holly-for the photos from the Tab Benoir concert, Nancy-for all the rolls of film, Hector-for taking charge, Heidi-for hanging out late nite in the make-shift-office, Joel and Jenny and Janine and Shaban-for taking the place of Bob and Carol and Ted and Alice, Laura D-great postcards, Steph-photo asst. to the stars, Tocco-moral support, Castanza-all the dating tips, Elaine-GET OUT!, Moon Pie-because the name has to be published, Shanda-because you swim!, KV-because you make good cookies and like Big Head Todd, Jane-all around extra help, the former Department of Anatomy for your darkroom, and last but not least, yes, ladies and gentlemen, Dean Bryant.

Everyone, thank you for all the help. Thanks for 4 or 5 great years. LA is nice but it is no Columbia. Sara and Mark, remember, five years and the Fish is ours. *Steve Tucker, M.D.*



LEFT:
"Hey, I
heard
back
from
Johns-
Hopkins!"



m u t a t i o n

u n i v e r s i t y o f m i s s o u r i
S C H O O L O F M E D I C I N E

DUE	RETURNED
JUN 16 2001	FEB 16 2004
FEB 17 2004	
FEB 08 2005	OCT 25 2004
FEB 02 2006	OCT 18 2005
FEB 06 2007	
FEB 06 2007	NOV 10 2008
FEB 06 2010	OCT 27 2009
OCT 24 2011	JUN 07 2010

BOOKS MAY BE RECALLED
BEFORE THEIR DUE DATES

Form 104A



030-100748997



